

European Technical Approval ETA-04/0095

English translation prepared by DIBt - Original version in German language

Handelsbezeichnung
Trade name

Würth Injektionssystem W-VIZ/S, W-VIZ/F, W-VIZ/A4, W-VIZ/HCR
Würth Injection System W-VIZ/S, W-VIZ/F, W-VIZ/A4, W-VIZ/HCR

Zulassungsinhaber
Holder of approval

Adolf Würth GmbH & Co. KG
Reinhold Würth Straße 12-17
74653 Künzelsau

Zulassungsgegenstand
und Verwendungszweck
*Generic type and use
of construction product*

Kraftkontrolliert spreizender Verbunddübel mit Ankerstange W-VIZ-A
und Innengewindehülse W-VIZ-IG zur Verankerung im Beton
*Torque controlled bonded anchor with anchor rod W-VIZ-A
and internal threaded rod W-VIZ-IG for use in concrete*

Geltungsdauer:
Validity: vom
from
bis
to

13 June 2013
7 June 2018

Herstellwerk
Manufacturing plant

Würth Herstellwerk W1, Deutschland

Diese Zulassung umfasst
This Approval contains

40 Seiten einschließlich 32 Anhänge
40 pages including 32 annexes

Diese Zulassung ersetzt
This Approval replaces

ETA-04/0095 mit Geltungsdauer vom 15.10.2010 bis 31.07.2014
ETA-04/0095 with validity from 15.10.2010 to 31.07.2014

I LEGAL BASES AND GENERAL CONDITIONS

- 1 This European technical approval is issued by Deutsches Institut für Bautechnik in accordance with:
 - Council Directive 89/106/EEC of 21 December 1988 on the approximation of laws, regulations and administrative provisions of Member States relating to construction products¹, modified by Council Directive 93/68/EEC² and Regulation (EC) N° 1882/2003 of the European Parliament and of the Council³;
 - *Gesetz über das In-Verkehr-Bringen von und den freien Warenverkehr mit Bauprodukten zur Umsetzung der Richtlinie 89/106/EWG des Rates vom 21. Dezember 1988 zur Angleichung der Rechts- und Verwaltungsvorschriften der Mitgliedstaaten über Bauprodukte und anderer Rechtsakte der Europäischen Gemeinschaften (Bauproduktengesetz - BauPG) vom 28. April 1998⁴, as amended by Article 2 of the law of 8 November 2011⁵;*
 - Common Procedural Rules for Requesting, Preparing and the Granting of European technical approvals set out in the Annex to Commission Decision 94/23/EC⁶;
 - Guideline for European technical approval of "Metal anchors for use in concrete - Part 5: Bonded anchors", ETAG 001-05.
- 2 Deutsches Institut für Bautechnik is authorized to check whether the provisions of this European technical approval are met. Checking may take place in the manufacturing plant. Nevertheless, the responsibility for the conformity of the products to the European technical approval and for their fitness for the intended use remains with the holder of the European technical approval.
- 3 This European technical approval is not to be transferred to manufacturers or agents of manufacturers other than those indicated on page 1, or manufacturing plants other than those indicated on page 1 of this European technical approval.
- 4 This European technical approval may be withdrawn by Deutsches Institut für Bautechnik, in particular pursuant to information by the Commission according to Article 5(1) of Council Directive 89/106/EEC.
- 5 Reproduction of this European technical approval including transmission by electronic means shall be in full. However, partial reproduction can be made with the written consent of Deutsches Institut für Bautechnik. In this case partial reproduction has to be designated as such. Texts and drawings of advertising brochures shall not contradict or misuse the European technical approval.
- 6 The European technical approval is issued by the approval body in its official language. This version corresponds fully to the version circulated within EOTA. Translations into other languages have to be designated as such.

¹ Official Journal of the European Communities L 40, 11 February 1989, p. 12

² Official Journal of the European Communities L 220, 30 August 1993, p. 1

³ Official Journal of the European Union L 284, 31 October 2003, p. 25

⁴ *Bundesgesetzblatt Teil I* 1998, p. 812

⁵ *Bundesgesetzblatt Teil I* 2011, p. 2178

⁶ Official Journal of the European Communities L 17, 20 January 1994, p. 34

II SPECIFIC CONDITIONS OF THE EUROPEAN TECHNICAL APPROVAL

1 Definition of product/ products and intended use

1.1 Definition of the construction product

The Würth Injection System W-VIZ/S, W-VIZ/F, W-VIZ/A4, W-VIZ/HCR is a torque controlled bonded anchor consisting of a mortar cartridge with Würth WIT-VM 100 or WIT-Express and an anchor rod with expansion cones and an external connection thread (type W-VIZ-A) or internal connection thread (type W-VIZ-IG).

The load transfer is realised by mechanical interlock of several cones in the bonding mortar and then via a combination of bonding and friction forces in the anchorage ground (concrete).

An illustration of the product and intended use is given in Annex 1.

1.2 Intended use

The anchor is intended to be used for anchorages for which requirements for mechanical resistance and stability and safety in use in the sense of the Essential Requirements 1 and 4 of Council Directive 89/106 EEC shall be fulfilled and failure of anchorages made with these products would cause risk to human life and/or lead to considerable economic consequences. Safety in case of fire (Essential Requirement 2) is not covered in this European technical approval.

The anchor is to be used only for anchorages subject to static or quasi-static loading in reinforced or unreinforced normal weight concrete of strength classes C20/25 at minimum and C50/60 at most according to EN 206:2000-12.

The anchor may be anchored in cracked and non-cracked concrete.

The anchor may be installed in dry or wet concrete; it must not be installed in flooded holes.

The anchor installed in hammer drilled holes may also be used under seismic action according to Annex 23 (performance category C2 only for sizes given in Annex 2).

The anchor with required bore hole diameters $d_0 \geq 14$ mm may be installed in dry or wet concrete or in water filled holes. The anchor with bore hole diameters $d_0 < 14$ mm may only be installed in dry or wet concrete.

The anchor may be used within the following temperature ranges:

Temperature range: -40 °C to +80 °C (max short term temperature +80 °C and max long term temperature +50 °C)

Temperature range: -40 °C to +120 °C (max short term temperature +120 °C and max long term temperature +72 °C)

Anchor rods made of zinc plated or hot-dip galvanised steel:

The element made of zinc plated or hot-dip galvanised steel may only be used in structures subject to dry internal conditions.

Anchor rods made of stainless steel (A4):

The element made of stainless steel with additional marking A4 may be used in structures subject to dry internal conditions and also in structures subject to external atmospheric exposure (including industrial and marine environment), or exposure to permanently damp internal conditions, if no particular aggressive conditions exist. Such particular aggressive conditions are e.g. permanent, alternating immersion in seawater or the splash zone of seawater, chloride atmosphere of indoor swimming pools or atmosphere with extreme chemical pollution (e.g. in desulphurization plants or road tunnels where de-icing materials are used).

Anchor rods made of high corrosion resistant steel (HCR):

The element made of high corrosion resistant steel with additional marking HCR may be used in structures subject to dry internal conditions and also in structures subject to external atmospheric exposure, in permanently damp internal conditions or in other particular aggressive conditions. Such particular aggressive conditions are e. g. permanent, alternating immersion in seawater or the splash zone of seawater, chloride atmosphere of indoor swimming pools or atmosphere with chemical pollution (e.g. in desulphurization plants or road tunnels where de-icing materials are used).

The provisions made in this European technical approval are based on an assumed working life of the anchor of 50 years. The indications given on the working life cannot be interpreted as a guarantee given by the producer, but are to be regarded only as a means for choosing the right products in relation to the expected economically reasonable working life of the works.

2 Characteristics of product and methods of verification**2.1 Characteristics of product**

The anchor corresponds to the drawings and provisions given in the Annexes. The characteristic material values, dimensions and tolerances of the anchor not indicated in the Annexes shall correspond to the respective values laid down in the technical documentation⁷ of this European technical approval.

The characteristic values for the design of anchorages are given in the Annexes.

Each anchor rod is marked in accordance with the Annexes.

Each mortar cartridge shall be marked with the identifying mark of the producer and with the trade name, processing notes, shelf life, hazard code, curing time and processing time (depending on temperature) in accordance with Annex 1.

2.2 Methods of verification

The assessment of fitness of the anchor for the intended use in relation to the requirements for mechanical resistance and stability and safety in use in the sense of the Essential Requirements 1 and 4 has been made in accordance with the "Guideline for European technical approval of Metal Anchors for Use in Concrete", Part 1 "Anchors in general" and Part 5 "Bonded anchors" as well as the Technical Report TR 018 "Torque-controlled bonded anchors", on the basis of Option 1 and ETAG 001 Annex E "Assessment of Metal Anchors under Seismic Action".

In addition to the specific clauses relating to dangerous substances contained in this European technical approval, there may be other requirements applicable to the products falling within its scope (e.g. transposed European legislation and national laws, regulations and administrative provisions). In order to meet the provisions of the Construction Products Directive, these requirements need also to be complied with, when and where they apply.

⁷

The technical documentation of this European technical approval is deposited at the Deutsches Institut für Bautechnik and, as far as relevant for the tasks of the approved bodies involved in the attestation of conformity procedure, is handed over to the approved bodies.

3 Evaluation and attestation of conformity and CE marking

3.1 System of attestation of conformity

According to the decision 96/582/EG of the European Commission⁸ the system 2(i) (referred to as System 1) of attestation of conformity applies.

This system of attestation of conformity is defined as follows:

System 1: Certification of the conformity of the product by an approved certification body on the basis of:

- (a) Tasks for the manufacturer:
 - (1) factory production control;
 - (2) further testing of samples taken at the factory by the manufacturer in accordance with a prescribed control plan;
- (b) Tasks for the approved body:
 - (3) initial type-testing of the product;
 - (4) initial inspection of factory and of factory production control;
 - (5) continuous surveillance, assessment and approval of factory production control.

Note: Approved bodies are also referred to as "notified bodies".

3.2 Responsibilities

3.2.1 Tasks of the manufacturer

3.2.1.1 Factory production control

The manufacturer shall exercise permanent internal control of production. All the elements, requirements and provisions adopted by the manufacturer shall be documented in a systematic manner in the form of written policies and procedures, including records of results performed. This production control system shall insure that the product is in conformity with this European technical approval.

The manufacturer may only use initial / raw / constituent materials stated in the technical documentation of this European technical approval.

The factory production control shall be in accordance with the control plan which is part of the technical documentation of this European technical approval. The control plan is laid down in the context of the factory production control system operated by the manufacturer and deposited at Deutsches Institut für Bautechnik.⁹

The results of factory production control shall be recorded and evaluated in accordance with the provisions of the control plan.

3.2.1.2 Other tasks of manufacturer

The manufacturer shall, on the basis of a contract, involve a body which is approved for the tasks referred to in section 3.1 in the field of anchors in order to undertake the actions laid down in section 3.2.2. For this purpose, the control plan referred to in sections 3.2.1.1 and 3.2.2 shall be handed over by the manufacturer to the approved body involved.

The manufacturer shall make a declaration of conformity, stating that the product is in conformity with the provisions of this European technical approval.

⁸ Official Journal of the European Communities L 254 of 08.10.1996.

⁹ The control plan is a confidential part of the European technical approval and only handed over to the approved body involved in the procedure of attestation of conformity. See section 3.2.2.

3.2.2 Tasks of approved bodies

The approved body shall perform the following tasks in accordance with the provisions laid down in the control plan:

- initial type-testing of the product,
- initial inspection of factory and of factory production control,
- continuous surveillance, assessment and approval of factory production control.

The approved body shall retain the essential points of its actions referred to above and state the results obtained and conclusions drawn in a written report.

The approved certification body involved by the manufacturer shall issue an EC certificate of conformity of the product stating the conformity with the provisions of this European technical approval.

In cases where the provisions of the European technical approval and its control plan are no longer fulfilled the certification body shall withdraw the certificate of conformity and inform Deutsches Institut für Bautechnik without delay.

3.3 CE marking

The CE marking shall be affixed on each packaging of anchors. The letters "CE" shall be followed by the identification number of the approved certification body, where relevant, and be accompanied by the following additional information:

- the name and address of the holder of the approval (legal entity responsible for the manufacture),
- the last two digits of the year in which the CE marking was affixed,
- the number of the EC certificate of conformity for the product,
- the number of the European technical approval,
- the number of the guideline for European technical approval,
- use category (ETAG 001-1 Option 1, in addition: seismic performance category C2 where applicable),
- size.

4 Assumptions under which the fitness of the product for the intended use was favourably assessed

4.1 Manufacturing

The anchor is manufactured in accordance with the provisions of the European technical approval using the automated manufacturing process as identified in the inspection of the plant by the Deutsches Institut für Bautechnik and the approved body and laid down in the technical documentation.

The European technical approval is issued for the product on the basis of agreed data/information, deposited with Deutsches Institut für Bautechnik, which identifies the product that has been assessed and judged. Changes to the product or production process, which could result in this deposited data/information being incorrect, should be notified to Deutsches Institut für Bautechnik before the changes are introduced. Deutsches Institut für Bautechnik will decide whether or not such changes affect the European technical approval and consequently the validity of the CE marking on the basis of the European technical approval and if so whether further assessment or alterations to the European technical approval shall be necessary.

4.2 Design of anchorages

The fitness of the anchor for the intended use is given under the following conditions:

The anchorages are designed either in accordance with

- ETAG 001 "Guideline for European technical approval of Metal Anchors for use in concrete", Annex C, method A

or in accordance with

- CEN/TS 1992-4:2009, design method A

and Technical Report TR 045 "Design of metal Anchors under Seismic Action" under the responsibility of an engineer experienced in anchorages and concrete work.

Anchorage shall be positioned outside of critical regions (e.g. plastic hinges) of the concrete structure. Fastenings in stand-off installation or with a grout layer under seismic action are not covered.

Verifiable calculation notes and drawings are prepared taking account of the loads to be anchored.

For the anchor rod W-VIZ-IG fastening screws or threaded rods made of appropriate steel and strength class acc. to Annex 24 shall be specified. The minimum screw-in depth $L_{s\text{dmin}}$ and maximum thread length L_{th} of the fastening screw or the threaded rod for installation of the fixture shall be met the requirements according to Annex 25. The length of the fastening screw or the threaded rod shall be determined depending on thickness of fixture, admissible tolerances, available thread length and minimum and maximum thread engagement length.

The position of the anchor is indicated on the design drawings (e.g. position of the anchor relative to reinforcement or to supports, etc.).

4.3 Installation of anchors

The fitness for use of the anchor can only be assumed if the anchor is installed as follows:

- anchor installation carried out by appropriately qualified personnel and under the supervision of the person responsible for technical matters of the site,
- anchor installation in accordance with the manufacturer's specifications and drawings using the tools indicated in the technical documentation of this European technical approval,
- use of the anchor only as supplied by the manufacturer without exchanging the components of an anchor,
- checks before placing the anchor to ensure that the strength class of the concrete in which the anchor is to be placed is in the range given and is not lower than that of the concrete to which the characteristic loads apply,
- check of concrete being well compacted, e.g. without significant voids,
- keeping the effective anchorage depth,
- edge distance and spacing not less than the specified values without minus tolerances,
- positioning of the drill holes without damaging the reinforcement,
- in case of aborted drill hole: the drill hole shall be filled with mortar,
- cleaning the drill hole following the manufacturer's installation instructions given in the Annexes,
- Installation conditions in dry or wet concrete or in water filled bore holes only as given in the Annexes, water filled bore holes (where admissible) must not be polluted – otherwise the cleaning of the drill hole must be repeated,
- Anchor installation according to the installation instructions given in the Annexes,

- the anchor component installation temperature shall be at least +5 °C; during curing of the injection mortar the temperature of the concrete must not fall below -5 °C; observing the curing time given in the Annexes until the anchor may be loaded,
- the fastening screw or threaded rods with washer and nut for the anchor rod W-VIZ-IG shall comply with specifications given in Annex 24.

5 Indications to the manufacturer

5.1 Responsibility of the manufacturer

It is in the responsibility of the manufacturer to ensure that the information on the specific conditions according to 1 and 2 including Annexes referred to and 4.2 and 4.3 as well as 5.2 is given to those who are concerned. This information may be made by reproduction of the respective parts of the European technical approval. In addition all installation data shall be shown clearly on the package and/or on an enclosed instruction sheet, preferably using illustration(s).

The minimum data required are:

- installation parameters acc. to Annex 5 for W-VIZ-A or Annex 25 for W-VIZ-IG,
- for W-VIZ-IG requirements for fastening screw or threaded rod, washer and nut acc. to Annex 24,
- information on the installation procedure, including cleaning of the hole with the cleaning equipments, preferably by means of an illustration,
- exact volume of injection mortar related to element size,
- Storage temperature of anchor components,
- Admissible temperature range of the concrete at installation,
- Processing time and minimum curing time depending on temperature given in the Annexes,
- identification of the manufacturing batch.

All data shall be presented in a clear and explicit form.

5.2 Packaging, transport and storage

The injection cartridges shall be protected against sun radiation and shall be stored according to the manufacturer's installation instructions in dry condition at temperatures of at least +5 °C to not more than +25 °C.

Mortar cartridges with expired shelf life must no longer be used.

The anchor shall only be packaged and supplied as a complete unit. Mortar cartridges may be packed separately from anchor rods (including nut and washer).

The manufacturer's installation instruction shall indicate that the Injection Mortar Würth WIT-VM 100 or WIT-Express shall be used with the corresponding anchor rods of the manufacturer according to Annex 2.

Andreas Kummerow
p.p. Head of Department

beglaubigt:
Baderschneider

Injection System W-VIZ

Mortar cartridge

Sealing cap

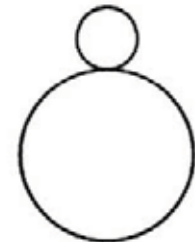
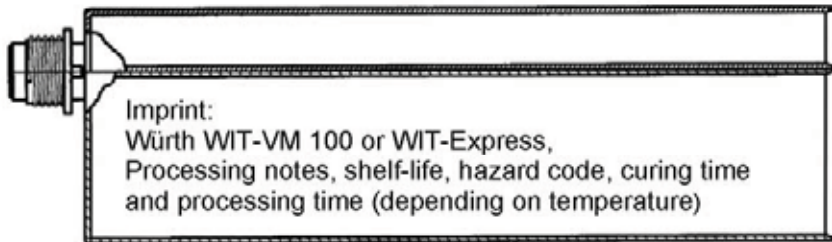
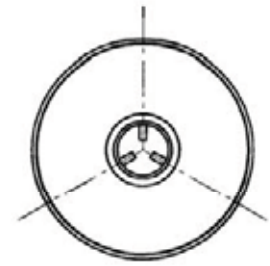
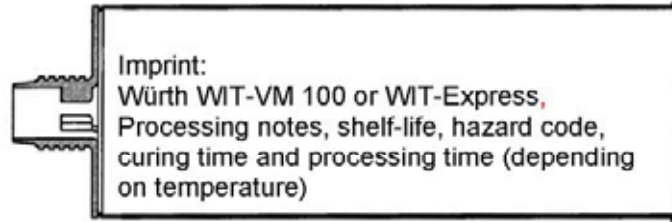

Static mixer



Blow-out pump



Air Blower

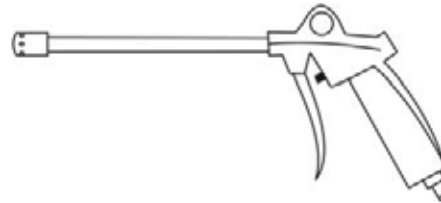

Cleaning Brush



Anchor rod W-VIZ-A ¹⁾

Washer

Hexagon nut

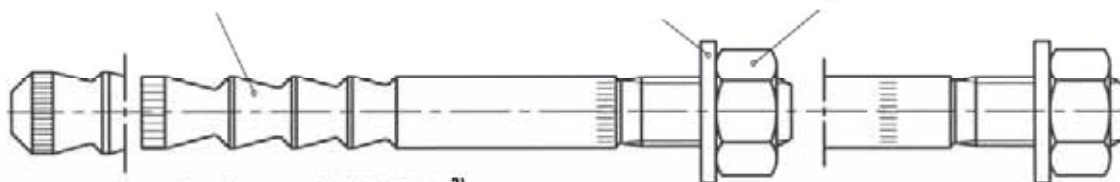

Anchor rod W-VIZ-IG ²⁾

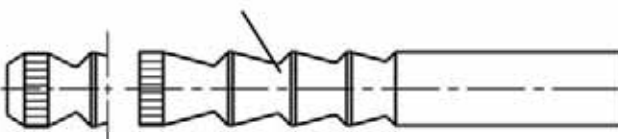

¹⁾ Number of cones see Table 1 / 2

²⁾ Number of cones see Table 31

Würth Injection System W-VIZ/S, W-VIZ/F, W-VIZ/A4, W-VIZ/HCR

Product

Annex 1

Anchor rod W-VIZ-A

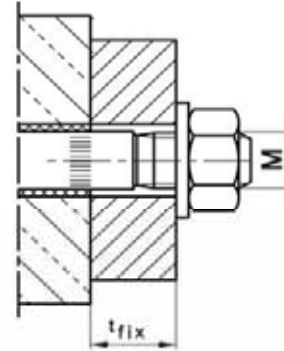
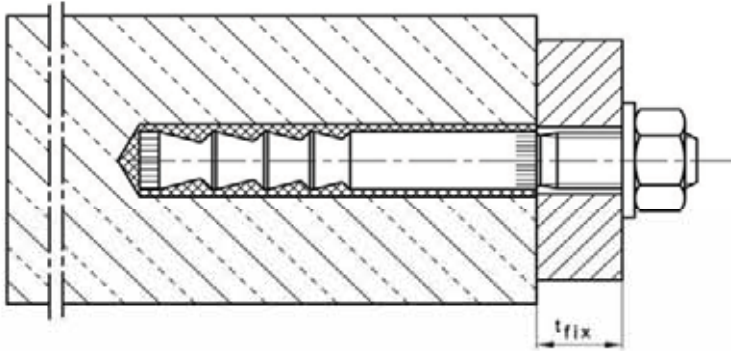

**Pre-setting
installation**
(and through-setting
installation
W-VIZ-A 75 M12, see
Annex 9)

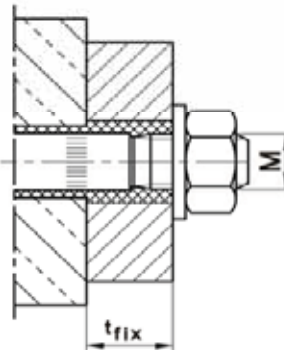
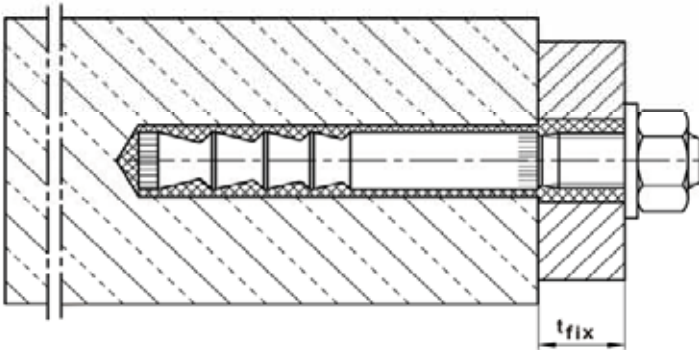

**Through-setting
installation**

Anchor rod W-VIZ-IG ¹⁾ (technical data from Annex 24)

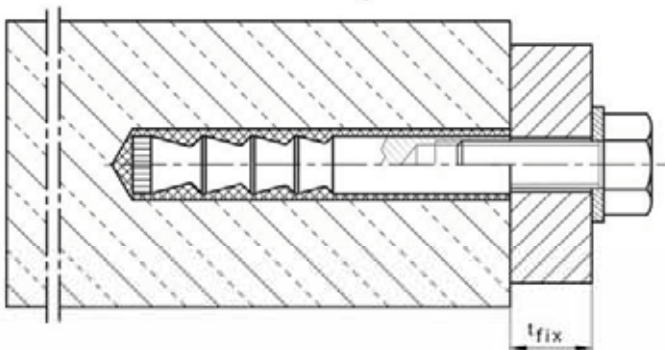

¹⁾ Illustration with hexagon head screw exemplified; other screws or threaded rods also permitted (see Annex 24, requirements of the fastening screw or threaded rod)

W-VIZ		M8	M10	M12	M16	M20	M24
Static or quasi-static action		✓					
Seismic action		-	C2				
W-VIZ-IG	M6	M8	M10	M12	M16	M20	
Static or quasi-static action		✓					
Seismic action		-					

Würth Injection System W-VIZ/S, W-VIZ/F, W-VIZ/A4, W-VIZ/HCR

Intended use

Annex 2

Marking: e.g. \diamond 95 VMZ 12-25 ...

- \diamond Identifying mark of manufacturing plant
- 95 Anchorage depth
- VMZ Trade name
- 12 Size of thread
- 25 Maximum thickness of fixture

- A4 additional marking of stainless steel A4
- HCR additional marking of high corrosion resistant steel HCR

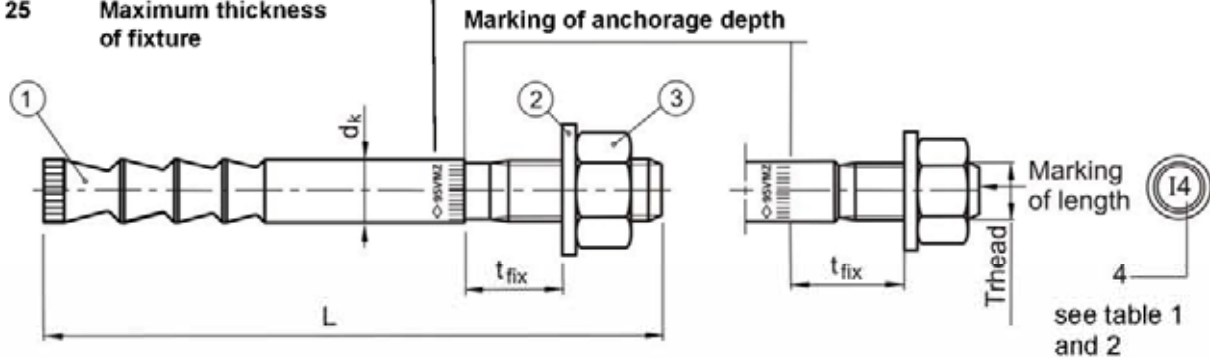

Marking of length	B	C	D	E	F	G	H	I	J	K	L	M
Length of anchor min \geq	50.8	63.5	76.2	88.9	101.6	114.3	127.0	139.7	152.4	165.1	177.8	190.5
Length of anchor max $<$	63.5	76.2	88.9	101.6	114.3	127.0	139.7	152.4	165.1	177.8	190.5	203.2

Marking of length	N	O	P	Q	R	S	T	U	V	W	X	Y	Z	>Z
Length of anchor min \geq	203.2	215.9	228.6	241.3	254.0	279.4	304.8	330.2	355.6	381.0	406.4	431.8	457.2	482.6
Length of anchor max $<$	215.9	228.6	241.3	254.0	279.4	304.8	330.2	355.6	381.0	406.4	431.8	457.2	482.6	

Table 1: Dimensions of anchor rod, W-VIZ-A M8 – M12

Anchor size W-VIZ-A		40 M8	50 M8	60 M10	75 M10	75 M12	70 M12	80 M12	95 M12	100 M12	110 M12	125 M12
Additional marking		1	2	1	2	1	2	3	4	5	6	7
1	Anchor rod											
	Thread	M8	M8	M10	M10	M12	M12	M12	M12	M12	M12	M12
	Number of cones	2	3	3	3	3	3	4	4	6	6	6
	d_k	= 8.0	8.0	9.7	9.7	10.7	12.5	12.5	12.5	12.5	12.5	12.5
	t_{fix} min	\geq 1	1	1	1	1	1	1	1	1	1	1
	t_{fix} max	\leq 3000	3000	3000	3000	3000	3000	3000	3000	3000	3000	3000
	L min		53	64	76	91	96	91	101	116	121	131
L max		3052	3063	3075	3090	3095	3090	3100	3115	3120	3130	3145
3	Hexagon nut	SW										
			13	13	17	17	19	19	19	19	19	19

Dimensions in mm

Würth Injection System W-VIZ/S, W-VIZ/F, W-VIZ/A4, W-VIZ/HCR

Dimensions of anchor rod,
Anchor rod W-VIZ-A M8 – M12

Annex 3

Table 2: Dimensions of anchor rod, W-VIZ-A M16 – M24

Anchor size W-VIZ-A		90 M16	105 M16	125 M16	145 M16	115 M20	170 M20 (LG)	190 M20 (LG)	170 M24 (LG)	200 M24 (LG)	225 M24 (LG)	
Additional marking		1	2	3	4	1	2	3	1	2	3	
1	Anchor rod	Thread	M16	M16	M16	M16	M20	M20	M20	M24	M24	M24
		Number of cones	3	4	6	6	3	6	6	6	6	6
		d_k	= 16.5	16.5	16.5	16.5	19.7	22.0	22.0	24.0	24.0	24.0
		t_{fix} min	≥ 1	1	1	1	1	20 (1)	20 (1)	20 (1)	20 (1)	20 (1)
		t_{fix} max	≤ 3000	3000	3000	3000	3000	3000	3000	3000	3000	3000
		L min	115	130	151	171	144	204	224	211	241	266
		L max	3114	3129	3150	3170	3143	3203	3223	3240	3240	3265
3	Hexagon nut	SW	24	24	24	24	30	30	30	36	36	36

Table 3: Materials W-VIZ-A

Part	Designation	Steel, zinc plated	Steel, hot-dip galvanised $\geq 40\mu\text{m}$	Stainless steel A4	High corrosion resistant steel (HCR)
1	Anchor rod	Steel acc. to EN 10087, galvanised and coated	Steel acc. to EN 10087, hot-dip galvanised and coated	Stainless steel, 1.4401, 1.4404, 1.4571, 1.4362, EN 10088, coated	High corrosion resistant steel 1.4529, 1.4565 acc. to EN 10088, coated
2	Washer	Steel, galvanised	Steel, galvanised	Stainless steel, 1.4401, 1.4571, EN 10088	High corrosion resistant steel 1.4529 or 1.4565, acc. to EN 10088
3	Hexagon nut DIN 934	Property class 8 acc. to EN ISO 898-2, galvanised	Property class 8 acc. to EN ISO 898-2, hot-dip galvanised	ISO 3506, A4-70, 1.4401, 1.4571, EN 10088	ISO 3506, Property class 70, high corrosion resistant steel 1.4529 or 1.4565, EN 10088
4	Mortar cartridge	Vinylester resin, styrene free, mixing ratio 1:10			

Würth Injection System W-VIZ/S, W-VIZ/F, W-VIZ/A4, W-VIZ/HCR

**Dimensions of anchor rod W-VIZ-A M16 – M24,
Materials,
Anchor rod W-VIZ-A**

Annex 4

Table 4: Installation conditions W-VIZ-A

Anchor size W-VIZ-A		M8 - M10 and 75 M12	70 M12 and 80 M12 - M24
Nominal diameter of drill hole	d_0 [mm]	< 14	≥ 14
Installation allowable in	dry concrete	yes	yes
	wet concrete	yes	yes
	water-filled hole ¹⁾	no	yes

¹⁾ Special requirements see Section 4.3.

Table 5: Installation parameters, W-VIZ-A M8 – M12

Anchor size W-VIZ-A		40 M8	50 M8	60 M10	75 M10	75 M12	70 M12	80 M12	95 M12	100 M12	110 M12	125 M12
Effective anchorage depth	$h_{ef} \geq$ [mm]	40	50	60	75	75	70	80	95	100	110	125
Nominal diameter of drill hole	$d_0 =$ [mm]	10	10	12	12	12	14	14	14	14	14	14
Depth of drill hole	$h_0 \geq$ [mm]	42	55	65	80	80	75	85	100	105	115	130
Diameter of cleaning brush	$D \geq$ [mm]	10.8	10.8	13.0	13.0	13.0	15.0	15.0	15.0	15.0	15.0	15.0
Installation torque	$T_{inst} \leq$ [Nm]	10	10	15	15	25	25	25	25	30	30	30
Diameter of clearance hole in the fixture												
Pre-setting installation	$d_f \leq$ [mm]	9	9	12	12	14	14	14	14	14	14	14
Through-setting installation ²⁾	$d_f \leq$ [mm]	-	-	14	14	14 ^{3)/16}	16	16	16	16	16	16

²⁾ After the installation the annular gap in the clearance hole in the fixture has to be filled completely by excess mortar..

³⁾ If hole diameter in the fixture $d_f \leq 14$ mm, annular gap does not have to be filled by mortar (see Annex 9).

Table 6: Installation parameters, W-VIZ-A M16 – M24

Anchor size W-VIZ-A		90 M16	105 M16	125 M16	145 M16	115 M20	170 M20 (LG)	190 M20 (LG)	170 M24 (LG)	200 M24 (LG)	225 M24 (LG)
Effective anchorage depth	$h_{ef} \geq$ [mm]	90	105	125	145	115	170	190	170	200	225
Nominal diameter of drill hole	$d_0 =$ [mm]	18	18	18	18	22	24	24	26	26	26
Depth of drill hole	$h_0 \geq$ [mm]	98	113	3	153	12	180	200	185	215	240
Diameter of cleaning brush	$D \geq$ [mm]	19.0	19.0	19.0	19.0	23.0	25.0	25.0	27.0	27.0	27.0
Installation torque	$T_{inst} \leq$ [Nm]	50	50	50	50	80	80	80	100	120	120
Diameter of clearance hole in the fixture											
Pre-setting installation	$d_f \leq$ [mm]	18	18	18	18	22	24 (22)	24 (22)	26	26	26
Through-setting installation ⁴⁾	$d_f \leq$ [mm]	20	20	20	20	24	26	26	28	28	28

⁴⁾ After the installation the annular gap in the clearance hole in the fixture has to be filled completely by excess mortar.

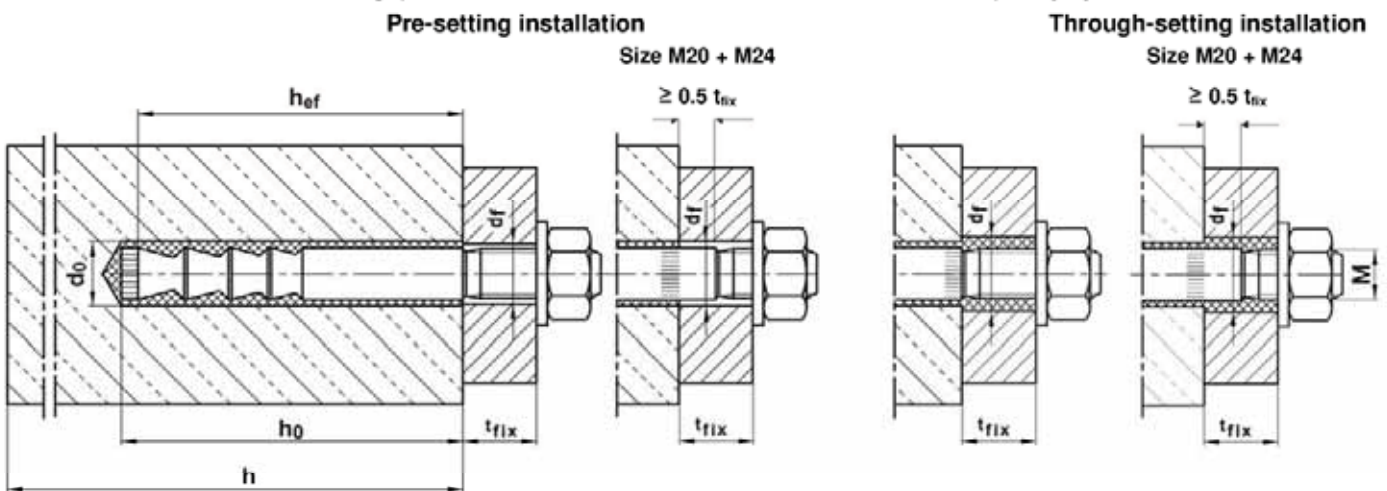

Würth Injection System W-VIZ/S, W-VIZ/F, W-VIZ/A4, W-VIZ/HCR

**Installation conditions,
Installation parameters,
Anchor rod W-VIZ-A**

Annex 5

Installation instructions W-VIZ-A

Making and cleaning of hammer drilled holes

1	Pre-setting installation V		Use Hammer drill or air drill with drill bit and depth gauge. Drill perpendicular to concrete surface.
	Through-setting installation D		Drill hole must be cleaned directly prior to installation of the anchor.
2	V		W-VIZ-A M8 - M16: Blow out drill hole from the bottom with Würth Blow-out pump at least two times. The Extension Tube with reduced diameter must be added to the Blow-out pump for the diameter M8.
			W-VIZ-A M20 - M24: Connect Würth Air Blower to compressed air (min. 6 bar, oil-free). Open air valve and blow out drill hole along the entire depth with back and forth motion at least two times.
	D		W-VIZ-A M10 - M16: Blow out drill hole from the bottom with Würth Blow-out pump at least two times.
			W-VIZ-A M20 - M24: Connect Würth Air Blower to compressed air (min. 6 bar, oil-free). Open air valve and blow out drill hole along the entire depth with back and forth motion at least two times.
3	V		Check diameter of Cleaning Brush. If Brush can be pushed into the drill hole without any resistance, it must be replaced. Chuck Brush into drill machine. Turn on drill machine. Brush drill hole back and forth along the entire drill hole depth at least two times while rotated by drill machine
	D		
4	V		W-VIZ-A M8 - M16: Blow out drill hole from the bottom with Würth Blow-out pump at least two times. The Extension Tube with reduced diameter must be added to the Blow-out pump for the diameter M8.
			W-VIZ-A M20 - M24: Connect Würth Air Blower to compressed air (min. 6 bar, oil-free). Open air valve and blow out drill hole along the entire depth with back and forth motion at least two times.
	D		W-VIZ-A M10 - M16: Blow out drill hole from the bottom with Würth Blow-out pump at least two times.
			W-VIZ-A M20 - M24: Connect Würth Air Blower to compressed air (min. 6 bar, oil-free). Open air valve and blow out drill hole along the entire depth with back and forth motion at least two times.

Würth Injection System W-VIZ/S, W-VIZ/F, W-VIZ/A4, W-VIZ/HCR

Installation instructions
- Making and cleaning of hammer drilled holes -
Anchor rod W-VIZ-A

Annex 6

Making and cleaning of diamond core drilled holes



1	Pre-setting installation V		Use diamond drill with diamond drill bit and depth gauge. Drill perpendicular to concrete surface.
	Through-setting installation D		Drill hole must be cleaned directly prior to installation of the anchor.
2	V		Remove drill core at least up to the nominal hole depth and check drill hole depth.
	D		
3	V		Flushing of drill hole: Flush drill hole with water, starting from the bottom, until clear water gets out of the drill hole.
	D		
4	V		Connect Würth Air Blower to compressed air (min. 6 bar, oil-free). Open air valve and blow out drill hole along the entire depth with back and forth motion at least two times.
	D		

Würth Injection System W-VIZ/S, W-VIZ/F, W-VIZ/A4, W-VIZ/HCR

Installation instructions
- Making and cleaning of diamond core drilled holes -
Anchor rod W-VIZ-A

Annex 7

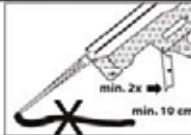
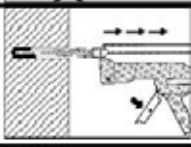
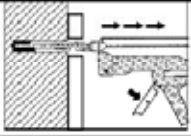
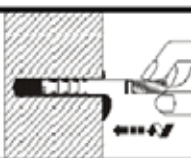
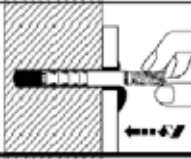
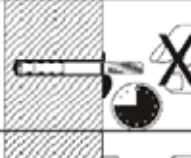
English translation prepared by DIBt

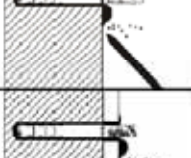
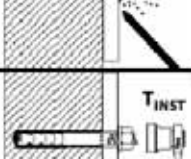
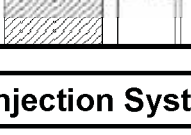
Injection			
5	D+V		Check expiration date on WIT-VM 100 or WIT-Express cartridge. Never use when expired. Remove cap from cartridge. Screw Mixer Nozzle on cartridge. When using a new cartridge always use a new Mixer Nozzle. Never use cartridge without Mixer Nozzle and never use Mixer Nozzle without helix inside.
6	D+V		Insert cartridge in Dispenser. Before injecting discard mortar (at least 2 full strokes or a line of 10 cm) until it shows a consistent grey colour. Never use this mortar.
7	V		Prior to injection check if Mixer Nozzle reaches the bottom of the drill hole. If it does not reach the bottom, plug Mixer Extension onto Mixer Nozzle in order to properly fill the drill hole. Fill hole with a sufficient quantity of injection mortar. Start from the bottom of the drill hole and work out to avoid trapping air pockets.
	D		
Insertion of anchor rod			
8	V		Insert the anchor rod W-VIZ-A by hand, rotating slightly up to the full embedment depth as marked on the anchor rod. The anchor rod is properly set when excess mortar seeps from the hole. If the hole is not completely filled, pull out anchor rod, let mortar cure, drill out hole and start again from No. 3.
	D		Insert the anchor rod W-VIZ-A by hand, rotating slightly up to the full embedment depth. After the installation the annular gap in the clearance hole in the fixture has to be filled completely by excess mortar. If the hole is not completely filled, pull out anchor rod, let mortar cure, drill out hole and start again from No. 3.
9	V		Follow minimum curing time shown in Table 7: and Table 8:. During curing time anchor rod must not be moved or loaded.
	D		
10	V		Remove excess mortar.
	D		
11	D+V		The fixture can be mounted after curing time. Apply installation torque T_{inst} according to Table 5: or Table 6: by using torque wrench.
Würth Injection System W-VIZ/S, W-VIZ/F, W-VIZ/A4, W-VIZ/HCR			Annex 8
Installation instructions - anchor installation - Anchor rod W-VIZ-A			

Electronic copy of the ETA by DIBt: ETA-04/0095

Installation instructions W-VIZ-A 75 M12
Through-setting installation with clearance between concrete and anchor plate

Work step 1-7 as illustrated in Annexes 6 - 8

Requirement: Diameter of clearance hole in the fixture $d_f \leq 14$ mm

8		Insert the anchor rod W-VIZ-A by hand, rotating slightly up to the full embedment depth.
9		Check if excess mortar seeps from the hole. If the hole is not completely filled, pull out anchor rod, let mortar cure, drill out hole and start again from No. 3. The annular gap in the fixture does not have to be filled.
10		During curing time as per Table 7: and Table 8: anchor rod must not be moved or loaded.
11		Washer and nut can be mounted after curing time and backfilling of anchor plate. Apply installation torque T_{inst} according to Table 5: by using torque wrench.

Table 7: Maximum processing time and minimum curing time WIT-VM 100

Temperature [°C] in the drill hole	Maximum processing time	Minimum curing time	
		dry concrete	wet concrete
+ 40 °C	1.4 min	15 min	30 min
+ 35 °C to +39 °C	1.4 min	20 min	40 min
+ 30 °C to +34 °C	2 min	25 min	50 min
+ 20 °C to +29 °C	4 min	45 min	1:30 h
+ 10 °C to + 19 °C	6 min	1:20 h	2:40 h
+ 5 °C to + 9 °C	12 min	2:00 h	4:00 h
0 °C to + 4 °C	20 min	3:00 h	6:00 h
- 4 °C to - 1 °C	45 min	6:00 h	12:00 h ¹⁾
- 5 °C	1:30 h	6:00 h	12:00 h ¹⁾

¹⁾ It must be ensured that icing does not occur in the drill hole. The hole must be drilled and cleaned directly prior to the installation of the anchor.

Würth Injection System W-VIZ/S, W-VIZ/F, W-VIZ/A4, W-VIZ/HCR

Installation instructions through-setting installation with clearance between concrete and anchor plate, Processing time, curing time WIT-VM 100, Anchor rod W-VIZ-A 75 M12

Annex 9

Table 8: Maximum processing time and minimum curing time WIT-Express

Temperature [°C] in the drill hole	Maximum processing time	Minimum curing time	
		dry concrete	wet concrete
+ 30 °C	1 min	10 min	20 min
+ 20 °C to + 29 °C	1 min	20 min	40 min
+ 10 °C to + 19 °C	3 min	40 min	80 min
+ 5 °C to + 9 °C	6 min	1:00 h	2:00 h
+ 0 °C to + 4 °C	10 min	2:00 h	4:00 h
- 4 °C to -1 °C	20 min	4:00 h	8:00 h ¹⁾
-5 °C	40 min	4:00 h	8:00 h ¹⁾

¹⁾ It must be ensured that icing does not occur in the drill hole. The hole must be drilled and cleaned directly prior to the installation of the anchor.

Table 9: Minimum thickness of concrete, minimum spacing and edge distance, W-VIZ-A M8 – M12

Anchor size W-VIZ-A			40 M8	50 M8	60 M10	75 M10	75 M12	70 M12	80 M12	95 M12	100 M12	110 M12	125 M12
Minimum thickness of concrete	h_{min}	[mm]	80	80	100	110 100 ²⁾	110	110	110	130 125 ²⁾	130	140	160
Cracked concrete													
Minimum spacing	s_{min}	[mm]	40	40	40	40	50	55	40	40	50	50	50
Minimum edge distance	c_{min}	[mm]	40	40	40	40	50	55	50	50	50	50	50
Non-cracked concrete													
Minimum spacing	s_{min}	[mm]	40	40	50	50	50	55	55	55	80 ³⁾	80 ³⁾	80 ³⁾
Minimum edge distance	c_{min}	[mm]	40	40	50	50	50	55	55	55	55 ³⁾	55 ³⁾	55 ³⁾

Table 10: Minimum thickness of concrete, minimum spacing and edge distance, W-VIZ-A M16 – M24

Anchor size W-VIZ-A			90 M16	105 M16	125 M16	145 M16	115 M20	170 M20 (LG)	190 M20 (LG)	170 M24 (LG)	200 M24 (LG)	225 M24 (LG)
Minimum thickness of concrete	h_{min}	[mm]	130	150	170 160 ²⁾	190 180 ²⁾	160	230 220 ²⁾	250 240 ²⁾	230 220 ²⁾	270 260 ²⁾	300 290 ²⁾
Cracked concrete												
Minimum spacing	s_{min}	[mm]	50	50	60	60	80	80	80	80	80	80
Minimum edge distance	c_{min}	[mm]	50	50	60	60	80	80	80	80	80	80
Non-cracked concrete												
Minimum spacing	s_{min}	[mm]	50	60	60	60	80	80	80	80	105	105
Minimum edge distance	c_{min}	[mm]	50	60	60	60	80	80	80	80	105	105

²⁾ The remote face of the concrete member shall be inspected to ensure there has been no break-through by drilling. In case of break-through the ground of the drill hole shall be closed with high strength mortar. The full bonded length h_{ef} shall be achieved and any potential loss of injection mortar shall be compensated.

³⁾ For an edge distance $c \geq 80$ mm a minimum spacing $s_{min} = 55$ mm is applicable.

Würth Injection System W-VIZ/S, W-VIZ/F, W-VIZ/A4, W-VIZ/HCR

**Processing time, curing time WIT-Express,
Minimum thickness of concrete, Minimum spacing and edge distance
Anchor rod W-VIZ-A**

Annex 10

Table 11: Characteristic values for tension load under static or quasi-static action, ETAG 001, Annex C, design method A, W-VIZ-A M8 – M12

Anchor size W-VIZ-A		40 M8	50 M8	60 M10	75 M10	75 M12	70 M12	80 M12	95 M12	100 M12	110 M12	125 M12	
Steel failure													
Characteristic tension resistance $N_{Rk,s}$	Steel, zinc plated	[kN]	15	18	25	25	35	49	54	54	57	57	57
	Stainless steel A4, HCR	[kN]	15	18	25	25	35	49	54	54	57	57	57
Partial safety factor	γ_{Ms}	[-]	1.5										
Pullout													
Characteristic resistance $N_{Rk,p}$ in cracked concrete C20/25	$50^{\circ}\text{C}^2/80^{\circ}\text{C}^3$	[kN]	1)										
	$72^{\circ}\text{C}^2/120^{\circ}\text{C}^3$	[kN]	5	7,5	12	12	12	16	20	20	30	30	30
Characteristic resistance $N_{Rk,p}$ in non-cracked concrete C20/25	$50^{\circ}\text{C}^2/80^{\circ}\text{C}^3$	[kN]	9	1)						40	1)	50	50
	$72^{\circ}\text{C}^2/120^{\circ}\text{C}^3$	[kN]	6	9	16	16	16	16	25	25	30	30	30
Splitting for standard thickness of concrete (The higher resistance of Case 1 and Case 2 may be applied.)													
Standard thickness of concrete	$h_{std} \geq 2 h_{ef}$	[mm]	100	100	120	150	150	140	160	190	200	220	250
Case 1													
Characteristic resistance on concrete C20/25	$N_{Rk,sp}^0$ 4)	[kN]	7.5	9	16	20	20	20	1)	30	40	40	40
Respective spacing	$S_{cr,sp}$	[mm]	3 h_{ef}										
Respective edge distance	$C_{cr,sp}$	[mm]	1.5 h_{ef}										
Case 2													
Spacing	$S_{cr,sp}$	[mm]	6 h_{ef}	6 h_{ef}	5 h_{ef}	7 h_{ef}	7 h_{ef}	5 h_{ef}	3 h_{ef}	5 h_{ef}	4 h_{ef}	6 h_{ef}	5 h_{ef}
Edge distance	$C_{cr,sp}$	[mm]	3 h_{ef}	3 h_{ef}	2.5 h_{ef}	3.5 h_{ef}	3.5 h_{ef}	2.5 h_{ef}	1.5 h_{ef}	2.5 h_{ef}	2 h_{ef}	3 h_{ef}	2.5 h_{ef}
Splitting for minimum thickness of concrete (The higher resistance of Case 1 and Case 2 may be applied.)													
Minimum thickness of concrete	$h_{min} \geq$	[mm]	80	80	100	100	110	110	110	125	130	140	160
Case 1													
Characteristic resistance in concrete C20/25	$N_{Rk,sp}^0$ 4)	[kN]	7.5	-	16	16	16	20	25	25	30	30	30
Respective spacing	$S_{cr,sp}$	[mm]	3 h_{ef}	-	3 h_{ef}								
Respective edge distance	$C_{cr,sp}$	[mm]	1.5 h_{ef}	-	1.5 h_{ef}								
Case 2													
Spacing	$S_{cr,sp}$	[mm]	6 h_{ef}	7 h_{ef}	6 h_{ef}	7 h_{ef}	7 h_{ef}	7 h_{ef}	6 h_{ef}	7 h_{ef}	6 h_{ef}	6 h_{ef}	6 h_{ef}
Edge distance	$C_{cr,sp}$	[mm]	3 h_{ef}	3.5 h_{ef}	3 h_{ef}	3.5 h_{ef}	3.5 h_{ef}	3.5 h_{ef}	3 h_{ef}	3.5 h_{ef}	3 h_{ef}	3 h_{ef}	3 h_{ef}
Increasing factors for $N_{Rk,p}$ and $N_{Rk,sp}^0$	ψ_c	[-]	1.10										
		[-]	1.22										
		[-]	1.41										
		[-]	1.48										
		[-]	1.55										
Concrete cone failure													
Effective anchorage depth	$h_{ef} \geq$	[mm]	40	50	60	75	75	70	80	95	100	11	1 5
Spacing	$S_{cr,N}$	[mm]	3 h_{ef}										
Edge distance	$C_{cr,N}$	[mm]	1.5 h_{ef}										
Partial safety factor	$\gamma_{Mp} = \gamma_{Msp} = \gamma_{Mc}$	[-]	1.5										

- 1) Pullout failure is not decisive
 2) Maximum long term temperature
 3) Maximum short term temperature
 4) For the proof against splitting failure according to ETAG 001 Annex C, $N_{Rk,c}^0$ in equation (5.3) has to be replaced by $N_{Rk,sp}^0$ with consideration of the member thickness ($\psi_{ucr,N} = 1.0$).

Würth Injection System W-VIZ/S, W-VIZ/F, W-VIZ/A4, W-VIZ/HCR

Characteristic values for tension load under static or quasi-static action, ETAG 001, Annex C, design method A, Anchor rod W-VIZ-A M8 – M12

Annex 11

Table 12: Characteristic values for tension load under static or quasi-static action, ETAG 001, Annex C, design method A, W-VIZ-A M16 – M24

Anchor size W-VIZ-A		90 M16	105 M16	125 M16	145 M16	115 M20	170 M20 (LG)	190 M20 (LG)	170 M24 (LG)	200 M24 (LG)	225 M24 (LG)	
Steel failure												
Characteristic tension	Steel, zinc plated	[kN]	88	95	111	111	96	188	188	222	222	
resistance $N_{Rk,s}$	Stainless steel A4, HCR	[kN]	88	95	111	111	114	165	165	194	194	
Partial safety factor	γ_{Ms}	[-]	1.5			1.68		1.5				
Pullout												
Characteristic resistance $N_{Rk,p}$ in	50°C ²⁾ /80°C ³⁾	[kN]	1)									
cracked concrete C20/25	72°C ²⁾ /120°C ³⁾	[kN]	25	30	50	50	30	60	60	75	75	
Characteristic resistance $N_{Rk,p}$ in	50°C ²⁾ /80°C ³⁾	[kN]	1)			75	1)					
non-cracked concrete C20/25	72°C ²⁾ /120°C ³⁾	[kN]	25	35	50	50	40	75	75	95	95	
Splitting for standard thickness of concrete (The higher resistance of Case 1 and Case 2 may be applied.)												
Standard thickness of concrete	$h_{std} \geq 2 h_{ef}$	[mm]	180	200	250	290	230	340	380	340	400	450
Case 1												
Characteristic resistance in	$N_{Rk,sp}^0$ 4)	[kN]	40	50	50	60	1)		115	1)		140
Respective spacing	$s_{cr,sp}$	[mm]	3 h_{ef}									
Respective edge distance	$c_{cr,sp}$	[mm]	1.5 h_{ef}									
Case 2												
Spacing	$s_{cr,sp}$	[mm]	4 h_{ef}	4 h_{ef}	4 h_{ef}	4 h_{ef}	3 h_{ef}	3 h_{ef}	4 h_{ef}	3 h_{ef}	3 h_{ef}	3.6 h_{ef}
Edge distance	$c_{cr,sp}$	[mm]	2 h_{ef}	2 h_{ef}	2 h_{ef}	2 h_{ef}	1.5 h_{ef}	1.5 h_{ef}	2 h_{ef}	1.5 h_{ef}	1.5 h_{ef}	1.8 h_{ef}
Splitting for minimum thickness of concrete (The higher resistance out of Case 1 and Case 2 may be applied.)												
Minimum thickness of concrete	$h_{min} \geq$	[mm]	130	150	160	180	160	220	240	220	260	290
Case 1												
Characteristic resistance in	$N_{Rk,sp}^0$ 4)	[kN]	35	50	40	50	-	75	75	1)	115	115
Respective spacing	$s_{cr,sp}$	[mm]	3 h_{ef}				-	3 h_{ef}				
Respective edge distance	$c_{cr,sp}$	[mm]	1.5 h_{ef}				-	1.5 h_{ef}				
Case 2												
Spacing	$s_{cr,sp}$	[mm]	5 h_{ef}	5 h_{ef}	6 h_{ef}	5 h_{ef}	5 h_{ef}	5.2 h_{ef}	4.4 h_{ef}	5.2 h_{ef}	4.4 h_{ef}	4.4 h_{ef}
Edge distance	$c_{cr,sp}$	[mm]	2.5 h_{ef}	2.5 h_{ef}	3 h_{ef}	2.5 h_{ef}	2.5 h_{ef}	2.6 h_{ef}	2.2 h_{ef}	2.6 h_{ef}	2.2 h_{ef}	2.2 h_{ef}
Increasing factors for $N_{Rk,p}$ and $N_{Rk,sp}^0$	ψ_C	C25/30	[-]	1.10								
		C30/37	[-]	1.22								
		C40/50	[-]	1.41								
		C45/55	[-]	1.48								
		C50/60	[-]	1.55								
Concrete cone failure												
Effective anchorage depth	$h_{ef} \geq$	[mm]	90	105	125	145	115	170	190	170	200	225
Spacing	$s_{cr,N}$	[mm]	3 h_{ef}									
Edge distance	$c_{cr,N}$	[mm]	1.5 h_{ef}									
Partial safety factor	$\gamma_{Mp} = \gamma_{Msp} = \gamma_{Mc}$	[-]	1.5									

1) Pullout failure is not decisive

2) Maximum long term temperature

3) Maximum short term temperature

4) For the proof against splitting failure according to ETAG 001 Annex C, $N_{Rk,c}^0$ in equation (5.3) has to be replaced by $N_{Rk,sp}^0$ with consideration of the member thickness ($\psi_{ucr,N} = 1.0$).

Würth Injection System W-VIZ/S, W-VIZ/F, W-VIZ/A4, W-VIZ/HCR

Characteristic values for tension load under static or quasi-static action, ETAG 001, Annex C, design method A, Anchor rod W-VIZ-A M16 – M24

Annex 12

Table 13: Displacements under tension loads, W-VIZ-A M8 – M12

Anchor size W-VIZ-A			40 M8	50 M8	60 M10	75 M10	75 M12	70 M12	80 M12	95 M12	100 M12	110 M12	125 M12
Tension load in cracked concrete	N	[kN]	4.3	6.1	8.0	11.1	11.1	10.0	12.3	15.9	17.1	19.8	24.0
Displacement	δ_{N0}	[mm]	0.5	0.5	0.5	0.6	0.6	0.6	0.6	0.6	0.6	0.7	0.7
	$\delta_{N\infty}$	[mm]	1.3										
Tension load in non-cracked concrete	N	[kN]	4.3	8.5	11.1	15.6	15.6	14.1	17.2	19.0	24.0	23.8	23.8
Displacement	δ_{N0}	[mm]	0.2	0.4	0.4	0.4	0.4	0.4	0.4	0.4	0.4	0.6	0.6
	$\delta_{N\infty}$	[mm]	1.3										

Table 14: Displacements under tension loads, W-VIZ-A M16 – M24

Anchor size W-VIZ-A			90 M16	105 M16	125 M16	145 M16	115 M20	170 M20 (LG)	190 M20 (LG)	170 M24 (LG)	200 M24 (LG)	225 M24 (LG)
Tension load in cracked concrete	N	[kN]	14.6	18.4	24.0	30.0	21.1	38.0	44.9	38.0	48.5	57.9
Displacement	δ_{N0}	[mm]	0.7	0.7	0.7	0.8	0.7	0.8	0.8	0.8	0.9	0.9
	$\delta_{N\infty}$	[mm]	1.3				1.1	1.3				
Tension load in non-cracked concrete	N	[kN]	20.5	25.9	33.0	35.7	29.6	53.3	63.0	53.3	67.9	81.1
Displacement	δ_{N0}	[mm]	0.6	0.6	0.6	0.6	0.5	0.6	0.6	0.6	0.6	0.6
	$\delta_{N\infty}$	[mm]	1.3				1.1	1.3				

Würth Injection System W-VIZ/S, W-VIZ/F, W-VIZ/A4, W-VIZ/HCR

**Displacements under tension load
Anchor rod W-VIZ-A**

Annex 13

Table 15: Characteristic values for shear load under static or quasi-static action, ETAG 001, Annex C, design method A, W-VIZ-A M8 – M12

Anchor size W-VIZ-A			40 M8	50 M8	60 M10	75 M10	75 M12	70 M12	80 M12	95 M12	100 M12	110 M12	125 M12
Steel failure without lever arm													
Characteristic shear resistance $V_{Rk,s}$	Steel, zinc plated	[kN]	14	14	21	21	34	34	34	34	34	34	34
	Stainless steel A4, HCR	[kN]	15	15	23	23	34	34	34	34	34	34	34
Partial safety factor	γ_{Ms}	[-]	1.25										
Steel failure with lever arm													
Characteristic bending moments $M_{Rk,s}^0$	Steel, zinc plated	[Nm]	30	30	60	60	105	105	105	105	105	105	105
	Stainless steel A4, HCR	[Nm]	30	30	60	60	105	105	105	105	105	105	105
Partial safety factor	γ_{Ms}	[-]	1.25										
Concrete pryout failure													
Factor in equation (5.6) ETAG 001, Annex C, 5.2.3.3	k	[-]	2										
Partial safety factor	γ_{Mcp}	[-]	1.5										
Concrete edge failure													
Effective length of anchor in shear load	l_f	[mm]	40	50	60	75	75	70	80	95	100	110	112
Diameter of anchor	d_{nom}	[mm]	10	10	12	12	12	14	14	14	14	14	14
Partial safety factor	γ_{Mc}	[-]	1.5										

Table 16: Displacements under shear loads, W-VIZ-A M8 – M12

Anchor size W-VIZ-A			40 M8	50 M8	60 M10	75 M10	75 M12	70 M12	80 M12	95 M12	100 M12	110 M12	125 M12
Shear load in non-cracked concrete	V	[kN]	8.3	8.3	13.3	13.3	19.3	19.3	19.3	19.3	19.3	19.3	19.3
Displacements	δ_{v0}	[mm]	2.4	2.5	2.9	2.9	3.3	3.3	3.3	3.3	3.3	3.3	3.3
	$\delta_{v\infty}$	[mm]	3.6	3.8	4.4	4.4	5.0	5.0	5.0	5.0	5.0	5.0	5.0

Würth Injection System W-VIZ/S, W-VIZ/F, W-VIZ/A4, W-VIZ/HCR

Characteristic values for shear load under static or quasi-static action, ETAG 001, Annex C, design method A, Displacements under shear loads, Anchor rod W-VIZ-A M8 – M12

Annex 14

Table 17: Characteristic values for shear load under static or quasi-static action, ETAG 001, Annex C, design method A, W-VIZ-A M16 – M24

Anchor size W-VIZ-A			90 M16	105 M16	125 M16	145 M16	115 M20	170 M20 (LG)	190 M20 (LG)	170 M24 (LG)	200 M24 (LG)	225 M24 (LG)
Steel failure without lever arm												
Characteristic shear resistance $V_{Rk,s}$	Steel, zinc plated	[kN]	63	63	63	63	70	149 ¹⁾ (98)	149 ¹⁾ (98)	178 ¹⁾ (141)	178 ¹⁾ (141)	178 ¹⁾ (141)
	Stainless steel A4, HCR	[kN]	63	63	63	63	86	131 ¹⁾ (86)	131 ¹⁾ (86)	156 ¹⁾ (123)	156 ¹⁾ (123)	156 ¹⁾ (123)
Partial safety factor	γ_{Ms}	[-]	1.25				1.4	1.25				
Steel failure with lever arm												
Characteristic bending moments $M_{Rk,s}^0$	Steel, zinc plated	[Nm]	266	266	266	266	392	519	519	896	896	896
	Stainless steel A4, HCR	[Nm]	266	266	266	266	454	454	454	784	784	784
Partial safety factor	γ_{Ms}	[-]	1.25				1.4	1.25				
Concrete pryout failure												
Factor in equation (5.6) ETAG Annex C, 5.2.3.3	k	[-]	2									
Partial safety factor	γ_{Mcp}	[-]	1.5									
Concrete edge failure												
Effective length of anchor in shear load	l_f	[mm]	90	105	125	144	115	170	190	170	200	208
Diameter of anchor	d_{nom}	[mm]	18	18	18	18	22	24	24	26	26	26
Partial safety factor	γ_{Mc}	[-]	1.5									

¹⁾ This values may only be applied if $l_f \geq 0.5 t_{fix}$

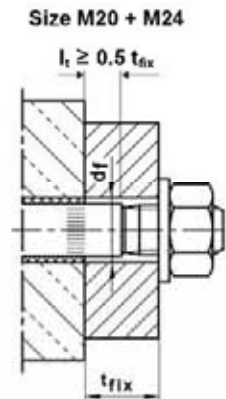

Table 18: Displacements under shear loads, W-VIZ-A M16 – M24

Anchor size W-VIZ-A			90 M16	105 M16	125 M16	145 M16	115 M20	170 M20 (LG)	190 M20 (LG)	170 M24 (LG)	200 M24 (LG)	225 M24 (LG)
Shear load in non-cracked concrete	V	[kN]	36	36	36	36	4	75 (49)	75 (49)	89 (71)	89 (71)	89 (71)
Displacements	δ_{V0}	[mm]	3.8	3.8	3.8	3.8	3.0	4.3 (3.0)	4.3 (3.0)	4.6 (3.5)	4.6 (3.5)	4.6 (3.5)
	$\delta_{V\infty}$	[mm]	5.7	5.7	5.7	5.7	4.5	6.5 (4.5)	6.5 (4.5)	6.9 (5.3)	6.9 (5.3)	6.9 (5.3)

Würth Injection System W-VIZ/S, W-VIZ/F, W-VIZ/A4, W-VIZ/HCR

Characteristic values for shear load under static or quasi-static action, ETAG 001, Annex C, design method A, Displacements under shear loads, Anchor rod W-VIZ-A M16 – M20

Annex 15

Table 19: Characteristic values for tension load under static or quasi-static action, CEN/TS 1992-4, design method A, W-VIZ-A M8 – M12

Anchor size W-VIZ-A			40 M8	50 M8	60 M10	75 M10	75 M12	70 M12	80 M12	95 M12	100 M12	110 M12	125 M12
Steel failure													
Characteristic tension resistance $N_{Rk,s}$	Steel, zinc plated	[kN]	15	18	25	25	35	49	54	54	57	57	57
	Stainless steel A4, HCR	[kN]	15	18	25	25	35	49	54	54	57	57	57
Partial safety factor	γ_{Ms}	[-]	1.5										
Pullout													
Characteristic resistance $N_{Rk,p}$ in cracked concrete C20/25	$50^\circ\text{C}^2/80^\circ\text{C}^3$	[kN]	1)										
	$72^\circ\text{C}^2/120^\circ\text{C}^3$	[kN]	5	7.5	12	12	12	16	20	20	30	30	30
Characteristic resistance $N_{Rk,p}$ in non-cracked concrete C20/25	k_s	[-]	7.2										
	$50^\circ\text{C}^2/80^\circ\text{C}^3$	[kN]	9	1)							40	1)	50
	$72^\circ\text{C}^2/120^\circ\text{C}^3$	[kN]	6	9	16	16	16	16	25	25	30	30	30
	k_s	[-]	10.1										
Splitting for standard thickness of concrete (The higher resistance of Case 1 and Case 2 may be applied).													
Standard thickness of concrete	$h_{std} \geq 2 h_{ef}$	[mm]	100	100	120	150	150	140	160	190	200	220	250
Case 1													
Characteristic resistance on concrete C20/25	$N^0_{Rk,sp}$ 4)	[kN]	7.5	9	16	20	20	20	1)	30	40	40	40
Respective spacing	$s_{cr,sp}$	[mm]	3 h_{ef}										
Respective edge distance	$c_{cr,sp}$	[mm]	1.5 h_{ef}										
Case 2													
Spacing	$s_{cr,sp}$	[mm]	6 h_{ef}	6 h_{ef}	5 h_{ef}	7 h_{ef}	7 h_{ef}	5 h_{ef}	3 h_{ef}	5 h_{ef}	4 h_{ef}	6 h_{ef}	5 h_{ef}
Edge distance	$c_{cr,sp}$	[mm]	3 h_{ef}	3 h_{ef}	2.5 h_{ef}	3.5 h_{ef}	3.5 h_{ef}	2.5 h_{ef}	1.5 h_{ef}	2.5 h_{ef}	2 h_{ef}	3 h_{ef}	2.5 h_{ef}
Splitting for minimum thickness of concrete (The higher resistance of Case 1 and Case 2 may be applied.)													
Minimum thickness of concrete	$h_{min} \geq$	[mm]	80	80	100	100	110	110	110	125	130	140	160
Case 1													
Characteristic resistance in concrete C20/25	$N^0_{Rk,sp}$ 4)	[kN]	7.5	-	16	16	16	20	25	25	30	30	30
Respective spacing	$s_{cr,sp}$	[mm]	3 h_{ef}	-	3 h_{ef}								
Respective edge distance	$c_{cr,sp}$	[mm]	1.5 h_{ef}	-	1.5 h_{ef}								
Case 2													
Spacing	$s_{cr,sp}$	[mm]	6 h_{ef}	7 h_{ef}	6 h_{ef}	7 h_{ef}	7 h_{ef}	7 h_{ef}	6 h_{ef}	7 h_{ef}	6 h_{ef}	6 h_{ef}	6 h_{ef}
Edge distance	$c_{cr,sp}$	[mm]	3 h_{ef}	3.5 h_{ef}	3 h_{ef}	3.5 h_{ef}	3.5 h_{ef}	3.5 h_{ef}	3 h_{ef}	3.5 h_{ef}	3 h_{ef}	3 h_{ef}	3 h_{ef}
Increasing factors for $N_{Rk,p}$ and $N^0_{Rk,sp}$	ψ_C	C25/30	[-]	1.10									
		C30/37	[-]	1.22									
		C40/50	[-]	1.41									
		C45/55	[-]	1.48									
		C50/60	[-]	1.55									
Concrete cone failure													
Effective anchorage depth	$h_{ef} \geq$	[mm]	40	50	60	75	75	70	80	95	100	110	125
Factor for cracked concrete	k_{cr}	[-]	7.2										
Factor for non-cracked concrete	k_{ucr}	[-]	10.1										
Spacing	$s_{cr,N}$	[mm]	3 h_{ef}										
Edge distance	$c_{cr,N}$	[mm]	1.5 h_{ef}										
Partial safety factor	$\gamma_{Mp} = \gamma_{Msp} = \gamma_{Mc}$	[-]	1.5										

1) Pullout failure is not decisive
 2) Maximum long term temperature
 3) Maximum short term temperature
 4) For the proof against splitting failure according to CEN/TS 1992-4-5, $N^0_{Rk,c}$ in equation (23) has to be replaced by $N^0_{Rk,sp}$ with consideration of the member thickness ($\psi_{ucr,N} = 1.0$).

Würth Injection System W-VIZ/S, W-VIZ/F, W-VIZ/A4, W-VIZ/HCR

Characteristic values for tension load under static or quasi-static action, CEN/TS 1992-4, design method A, Anchor rod W-VIZ-A M8 – M12

Annex 16

Table 20: Characteristic values for tension load under static or quasi-static action, CEN/TS 1992-4, design method A, W-VIZ-A M16 – M24

Anchor size W-VIZ-A			90 M16	105 M16	125 M16	145 M16	115 M20	170 M20 (LG)	190 M20 (LG)	170 M24 (LG)	200 M24 (LG)	225 M24 (LG)
Steel failure												
Characteristic tension resistance $N_{Rk,s}$	Steel, zinc plated	[kN]	88	95	111	111	96	188	188	222	222	222
	Stainless steel A4, HCR	[kN]	88	95	111	111	114	165	165	194	194	194
Partial safety factor	γ_{Ms}	[-]	1.5				1.68	1.5				
Pullout												
Characteristic resistance $N_{Rk,p}$ in cracked concrete C20/25	$50^\circ\text{C}^2)/80^\circ\text{C}^3)$	[kN]	1)									
	$72^\circ\text{C}^2)/120^\circ\text{C}^3)$	[kN]	25	30	50	50	30	60	60	75	75	75
	k_s	[-]	7.2									
Characteristic resistance $N_{Rk,p}$ in non-cracked concrete C20/25	$50^\circ\text{C}^2)/80^\circ\text{C}^3)$	[kN]	1)			75	1)					
	$72^\circ\text{C}^2)/120^\circ\text{C}^3)$	[kN]	25	35	50	50	40	75	75	95	95	95
	k_s	[-]	10.2									
Splitting for standard thickness of concrete (The higher resistance of Case 1 and Case 2 may be applied.)												
Standard thickness of concrete	$h_{std} \geq 2 h_{ef}$	[mm]	180	200	250	290	230	340	380	340	400	450
Case 1												
Characteristic resistance in cracked concrete C20/25	$N_{Rk,sp}^0$ 4)	[kN]	40	50	50	60	1)		115	1)		140
Respective spacing	$s_{cr,sp}$	[mm]	3 h_{ef}									
Respective edge distance	$c_{cr,sp}$	[mm]	1.5 h_{ef}									
Case 2												
Spacing	$s_{cr,sp}$	[mm]	4 h_{ef}	4 h_{ef}	4 h_{ef}	4 h_{ef}	3 h_{ef}	3 h_{ef}	4 h_{ef}	3 h_{ef}	3 h_{ef}	3.6 h_{ef}
Edge distance	$c_{cr,sp}$	[mm]	2 h_{ef}	2 h_{ef}	2 h_{ef}	2 h_{ef}	1.5 h_{ef}	1.5 h_{ef}	2 h_{ef}	1.5 h_{ef}	1.5 h_{ef}	1.8 h_{ef}
Splitting for minimum thickness of concrete (The higher resistance out of Case 1 and Case 2 may be applied.)												
Minimum thickness of concrete	$h_{min} \geq$	[mm]	130	150	160	180	160	220	240	220	260	290
Case 1												
Characteristic resistance in concrete C20/25	$N_{Rk,sp}^0$ 4)	[kN]	35	50	40	50	-	75	75	1)		115
Respective spacing	$s_{cr,sp}$	[mm]	3 h_{ef}				-	3 h_{ef}				
Respective edge distance	$c_{cr,sp}$	[mm]	1.5 h_{ef}				-	1.5 h_{ef}				
Case 2												
Spacing	$s_{cr,sp}$	[mm]	5 h_{ef}	5 h_{ef}	6 h_{ef}	5 h_{ef}	5 h_{ef}	5.2 h_{ef}	4.4 h_{ef}	5.2 h_{ef}	4.4 h_{ef}	4.4 h_{ef}
Edge distance	$c_{cr,sp}$	[mm]	2.5 h_{ef}	2.5 h_{ef}	3 h_{ef}	2.5 h_{ef}	2.5 h_{ef}	2.6 h_{ef}	2.2 h_{ef}	2.6 h_{ef}	2.2 h_{ef}	2.2 h_{ef}
Increasing factors for $N_{Rk,p}$ and $N_{Rk,sp}^0$	ψ_c	C25/30	[-]	1.10								
		C30/37	[-]	1.22								
		C40/50	[-]	1.41								
		C45/55	[-]	1.48								
		C50/60	[-]	1.55								
Concrete cone failure												
Effective anchorage depth	$h_{ef} \geq$	[mm]	90	105	125	145	115	170	190	170	200	225
Factor for cracked concrete	k_{cr}	[-]	7.2									
Factor for non-cracked concrete	k_{ucr}	[-]	10.1									
Spacing	$s_{cr,N}$	[mm]	3 h_{ef}									
Edge distance	$c_{cr,N}$	[mm]	1.5 h_{ef}									
Partial safety factor	$\gamma_{Mp} = \gamma_{Msp} = \gamma_{Mc}$ 5)	[-]	1.5									

- 1) Pullout failure is not decisive
 2) Maximum long term temperature
 3) Maximum short term temperature
 4) For the proof against splitting failure according to CEN/TS 1992-4-5, $N_{Rk,c}^0$ in equation (23) has to be replaced by $N_{Rk,sp}^0$ with consideration of the member thickness ($\psi_{ucr,N} = 1.0$).

Würth Injection System W-VIZ/S, W-VIZ/F, W-VIZ/A4, W-VIZ/HCR

Characteristic values for tension load under static or quasi-static action, CEN/TS 1992-4, design method A, Anchor rod W-VIZ-A M16 – M20

Annex 17

Table 21: Displacements under tension loads, W-VIZ-A M8 – M12

Anchor size W-VIZ-A			40 M8	50 M8	60 M10	75 M10	75 M12	70 M12	80 M12	95 M12	100 M12	110 M12	125 M12
Tension load in cracked concrete	N	[kN]	4.3	6.1	8.0	11.1	11.1	10.0	12.3	15.9	17.1	19.8	24.0
Displacement	δ_{N0}	[mm]	0.5	0.5	0.5	0.6	0.6	0.6	0.6	0.6	0.6	0.7	0.7
	$\delta_{N\infty}$	[mm]	1.3										
Tension load in non-cracked concrete	N	[kN]	4.3	8.5	11.1	15.6	15.6	14.1	17.2	19.0	24.0	23.8	23.8
Displacement	δ_{N0}	[mm]	0.2	0.4	0.4	0.4	0.4	0.4	0.4	0.4	0.4	0.6	0.6
	$\delta_{N\infty}$	[mm]	1.3										

Table 22: Displacements under tension loads, W-VIZ-A M16 – M24

Anchor size W-VIZ-A			90 M16	105 M16	125 M16	145 M16	115 M20	170 M20 (LG)	190 M20 (LG)	170 M24 (LG)	200 M24 (LG)	225 M24 (LG)
Tension load in cracked concrete	N	[kN]	14.6	18.4	24.0	30.0	21.1	38.0	44.9	38.0	48.5	57.9
Displacement	δ_{N0}	[mm]	0.7	0.7	0.7	0.8	0.7	0.8	0.8	0.8	0.9	0.9
	$\delta_{N\infty}$	[mm]	1.3				1.1	1.3				
Tension load in non-cracked concrete	N	[kN]	20.5	25.9	33.0	35.7	29.6	53.3	63.0	53.3	67.9	81.1
Displacement	δ_{N0}	[mm]	0.6	0.6	0.6	0.6	0.5	0.6	0.6	0.6	0.6	0.6
	$\delta_{N\infty}$	[mm]	1.3				1.1	1.3				

Würth Injection System W-VIZ/S, W-VIZ/F, W-VIZ/A4, W-VIZ/HCR

**Displacements under tension load
Anchor rod W-VIZ-A**

Annex 18

Table 23: Characteristic values for shear load under static or quasi-static action, CEN/TS 1992-4, design method A, W-VIZ-A M8 – M12

Anchor size W-VIZ-A			40 M8	50 M8	60 M10	75 M10	75 M12	70 M12	80 M12	95 M12	100 M12	110 M12	125 M12
Steel failure without lever arm													
Characteristic shear resistance $V_{Rk,s}$	Steel, zinc plated	[kN]	14	14	21	21	34	34	34	34	34	34	34
	Stainless steel A4, HCR	[kN]	15	15	23	23	34	34	34	34	34	34	34
Ductility factor k_2		[-]	1,0										
Partial safety factor γ_{Ms}		[-]	1.25										
Steel failure with lever arm													
Characteristic bending moments $M_{Rk,s}^0$	Steel, zinc plated	[Nm]	30	30	60	60	105	105	105	105	105	105	105
	Stainless steel A4, HCR	[Nm]	30	30	60	60	105	105	105	105	105	105	105
Partial safety factor γ_{Ms}		[-]	1.25										
Concrete pryout failure													
Factor in equation (27) CEN/TS 1992-4-5, 6.3.3 k_3		[-]	2										
Partial safety factor γ_{Mcp}		[-]	1.5										
Concrete edge failure													
Effective length of anchor in shear load l_f		[mm]	40	50	60	75	75	70	80	95	100	110	112
Diameter of anchor d_{nom}		[mm]	10	10	12	12	12	14	14	14	14	14	14
Partial safety factor γ_{Mc}		[-]	1.5										

Table 24: Displacements under shear loads W-VIZ-A M8 – M12

Anchor size W-VIZ-A			40 M8	50 M8	60 M10	75 M10	75 M12	70 M12	80 M12	95 M12	100 M12	110 M12	125 M12
Shear load in non-cracked concrete V		[kN]	8.3	8.3	13.3	13.3	19.3	19.3	19.3	19.3	19.3	19.3	19.3
Displacements	δ_{V0}	[mm]	2.4	2.5	2.9	2.9	3.3	3.3	3.3	3.3	3.3	3.3	3.3
	$\delta_{V\infty}$	[mm]	3.6	3.8	4.4	4.4	5.0	5.0	5.0	5.0	5.0	5.0	5.0

Würth Injection System W-VIZ/S, W-VIZ/F, W-VIZ/A4, W-VIZ/HCR

Characteristic values for tension load under static or quasi-static action, CEN/TS 1992-4, design method A, Displacements under shear loads, Anchor rod W-VIZ-A M8 – M12

Annex 19

Table 25: Characteristic values for tension load under static or quasi-static action, CEN/TS 1992-4, design method A, W-VIZ-A M16 – M24

Anchor size W-VIZ-A			90 M16	105 M16	125 M16	145 M16	115 M20	170 M20 (LG)	190 M20 (LG)	170 M24 (LG)	200 M24 (LG)	225 M24 (LG)
Steel failure without lever arm												
Characteristic shear resistance $V_{Rk,s}$	Steel, zinc plated	[kN]	63	63	63	63	70	149 ¹⁾ (98)	149 ¹⁾ (98)	178 ¹⁾ (141)	178 ¹⁾ (141)	178 ¹⁾ (141)
	Stainless steel A4, HCR	[kN]	63	63	63	63	86	131 ¹⁾ (86)	131 ¹⁾ (86)	156 ¹⁾ (123)	156 ¹⁾ (123)	156 ¹⁾ (123)
Ductility factor	k_2	[-]	1,0									
Partial safety factor	γ_{Ms}	[-]	1,25				1,4	1,25				
Steel failure with lever arm												
Characteristic bending moments $M_{Rk,s}^0$	Steel, zinc plated	[Nm]	266	266	266	266	392	519	519	896	896	896
	Stainless steel A4, HCR	[Nm]	266	266	266	266	454	454	454	784	784	784
Partial safety factor	γ_{Ms}	[-]	1,25				1,4	1,25				
Concrete pryout failure												
Factor in equation (27) CEN/TS 1992-4-5, 6.3.3	k_3	[-]	2									
Partial safety factor	γ_{Mcp}	[-]	1,5									
Concrete edge failure												
Effective length of anchor in shear load	l_f	[mm]	90	105	125	144	115	170	190	170	200	208
Diameter of anchor	d_{nom}	[mm]	18	18	18	18	22	24	24	26	26	26
Partial safety factor	γ_{Mc}	[-]	1,5									

¹⁾ This values may only be applied if $l_f \geq 0.5 t_{fix}$

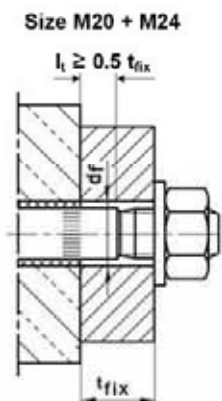

Table 26: Displacements under shear loads W-VIZ-A M16 – M24

Anchor size W-VIZ-A			90 M16	105 M16	125 M16	145 M16	115 M20	170 M20 (LG)	190 M20 (LG)	170 M24 (LG)	200 M24 (LG)	225 M24 (LG)
Shear load in non-cracked concrete	V	[kN]	36	36	36	36	4	75 (49)	75 (49)	89 (71)	89 (71)	89 (71)
Displacements	δ_{V0}	[mm]	3.8	3.8	3.8	3.8	3.0	4.3 (3.0)	4.3 (3.0)	4.6 (3.5)	4.6 (3.5)	4.6 (3.5)
	$\delta_{V\infty}$	[mm]	5.7	5.7	5.7	5.7	4.5	6.5 (4.5)	6.5 (4.5)	6.9 (5.3)	6.9 (5.3)	6.9 (5.3)

Würth Injection System W-VIZ/S, W-VIZ/F, W-VIZ/A4, W-VIZ/HCR

Characteristic values for tension load under static or quasi-static action, CEN/TS 1992-4, design method A, Displacements under shear loads, Anchor rod W-VIZ-A M16 – M24

Annex 20

Table 27: Characteristic values for seismic action, Category C2, design method A, W-VIZ-A M10 – M12

Anchor size W-VIZ-A		60 M10	75 M10	75 M12	70 M12	80 M12	95 M12	100 M12	110 M12	125 M12
Tension load										
Steel failure										
Characteristic tension resistance $N_{Rk,s,seis}$	Steel, zinc plated	[kN]	25	35	49	54			57	
	Stainless steel A4, HCR	[kN]	25	35	49	54			57	
Partial safety factor	$\gamma_{Ms,seis}$	[-]	1.5							
Pullout failure										
Characteristic resistance in cracked concrete C20/25 $N_{Rk,p,seis}$	$50^{\circ}C^2/80^{\circ}C^3$	[kN]	6.8				10.9			
	$72^{\circ}C^2/120^{\circ}C^3$	[kN]	5.1				8.4			
Partial safety factor	$\gamma_{Mp,seis}$	[-]	1.5							
Displacements under seismic tension loads										
Displacements for DLS	$\delta_{N,seis(DLS)}^1$	[mm]	1.01				1.33			
Displacements for ULS	$\delta_{N,seis(ULS)}^1$	[mm]	2.99				3.93			
Shear load										
Steel failure without lever arm										
Characteristic shear resistance $V_{Rk,s,seis}$	Steel, zinc plated	[kN]	12.6	27.2						
	Stainless steel A4, HCR	[kN]	13.8	27.2						
Partial safety factor	$\gamma_{Ms,V,seis}$	[-]	1.25							
Displacements under seismic shear loads										
Displacements for DLS	$\delta_{V,seis(DLS)}^1$	[mm]	2.06	2.47						
Displacements for ULS	$\delta_{V,seis(ULS)}^1$	[mm]	3.74	5.12						
Steel failure with lever arm										
Characteristic resistance	$M_{Rk,s,seis}^0$	[Nm]	no performance determined							
<p>The characteristic seismic resistance $F_{k,seis}$ of a fastening shall be determined as</p> $F_{k,seis} = \alpha_{gap} \cdot \alpha_{seis} \cdot F_{Rk,seis}^0$ <p>where α_{gap} reduction factor to take into account inertia effects due to an annular gap between fastener and fixture in case of shear loading.</p> <p>= 1.0 no hole clearance between fastener and fixture</p> <p>= 0.5 connections with hole clearance according to Table 1, CEN/TS 1992-4-1 or to Table 4.1, ETAG 001, Annex C</p> <p>α_{seis} reduction factor to take into account the influence of large cracks and scatter of load-displacement curves, see Table 30.</p> <p>$F_{Rk,seis}^0$ basic characteristic seismic resistance to the failure modes given in Table 27, for all other failure modes, the values for static or quasi-static action may be applied.</p> <p>$\gamma_{Ms,seis}, \gamma_{Mp,seis}$ partial safety factor für seismic action for the failure modes given in Table 27, for all other failure modes, the value for static or quasi-static action may be applied.</p>										
<p>DLS – Damage Limit State ULS – Ultimate Limit State</p>										

¹⁾ The listed displacements represent mean values.
²⁾ Maximum long term temperature
³⁾ Maximum short term temperature

Würth Injection System W-VIZ/S, W-VIZ/F, W-VIZ/A4, W-VIZ/HCR

Characteristic values for seismic action, Category C2, design method A, Anchor rod W-VIZ-A M10 – M12

Annex 21

Table 28: Characteristic values for seismic action, Category C2, design method A, W-VIZ-A M16

Anchor size W-VIZ-A			90 M16	105 M16	125 M16	145 M16	
Tension load							
Steel failure							
Characteristic tension resistance $N_{Rk,s,seis}$	Steel, zinc plated	[kN]	88	95	111		
	Stainless steel A4, HCR	[kN]	88	95	111		
Partial safety factor		$\gamma_{Ms,seis}$	[-]				1.5
Pullout failure							
Characteristic resistance in cracked concrete C20/25 $N_{Rk,p,seis}$	$50^{\circ}C^2/80^{\circ}C^3$	[kN]	12.9	16.2	21.1		
	$72^{\circ}C^2/120^{\circ}C^3$	[kN]	10.5	14.7	20.9		
Partial safety factor		$\gamma_{Mp,seis}$	[-]				1.5
Displacements under seismic tension loads							
Displacements for DLS		$\delta_{N,seis(DLS)}^{1)}$	[mm]	1.48			
Displacements for ULS		$\delta_{N,seis(ULS)}^{1)}$	[mm]	4.43			
Shear load							
Steel failure without lever arm							
Characteristic shear resistance $V_{Rk,s,seis}$	Steel, zinc plated	[kN]	50.4				
	Stainless steel A4, HCR	[kN]	50.4				
Partial safety factor		$\gamma_{Ms,V,seis}$	[-]				1.25
Displacements under seismic shear loads							
Displacements for DLS		$\delta_{V,seis(DLS)}^{1)}$	[mm]	2.91			
Displacements for ULS		$\delta_{V,seis(ULS)}^{1)}$	[mm]	6.80			
Steel failure with lever arm							
Characteristic resistance		$M^0_{Rk,s,seis}$	[Nm]	no performance determined			
<p>The characteristic seismic resistance $F_{k,seis}$ of a fastening shall be determined as</p> $F_{k,seis} = \alpha_{gap} \cdot \alpha_{seis} \cdot F^0_{Rk,seis}$ <p>where</p> <ul style="list-style-type: none"> α_{gap} reduction factor to take into account inertia effects due to an annular gap between fastener and fixture in case of shear loading. <ul style="list-style-type: none"> = 1.0 no hole clearance between fastener and fixture = 0.5 connections with hole clearance according to Table 1, CEN/TS 1992-4-1 or to Table 4.1, ETAG 001, Annex C α_{seis} reduction factor to take into account the influence of large cracks and scatter of load-displacement curves, see Table 30. $F^0_{Rk,seis}$ basic characteristic seismic resistance to the failure modes given in Table 28, for all other failure modes, the values for static or quasi-static action may be applied. <p>$\gamma_{Ms,seis}, \gamma_{Mp,seis}$ partial safety factor für seismic action for the failure modes given in Table 28, for all other failure modes, the value for static or quasi-static action may be applied.</p>							
<p>DLS – Damage Limit State ULS – Ultimate Limit State</p>							

¹⁾ The listed displacements represent mean values.
²⁾ Maximum long term temperature
³⁾ Maximum short term temperature

Würth Injection System W-VIZ/S, W-VIZ/F, W-VIZ/A4, W-VIZ/HCR

Characteristic values for seismic action, Category C2, design method A, Anchor rod W-VIZ-A M16

Annex 22

The seismic performance of anchors subjected to seismic loading is categorized by performance categories C1 and C2. The assignment of the seismic performance categories C1 and C2 to the seismicity level and building importance classes is in the responsibility of each individual Member State.

The values of a_g or that of the product $a_g \cdot S$ used in a Member State to define thresholds for the seismicity classes may be found in its National Annex of EN 1998-1:2004 (EC8) and may be different to the values given in Table 29.

The recommended categories C1 and C2 given in Table 29 are given in the case that no national requirements are defined.

Table 29: Recommended seismic performance categories for anchors

Seismicity level ^{a)}		Importance Class acc. to EN 1998-1:2004, 4.2.5			
Class	$a_g \cdot S$ ^{c)}	I	II	III	IV
Very low ^{b)}	$a_g \cdot S \leq 0.05 \text{ g}$	No additional requirement			
low ^{b)}	$0.05 \text{ g} < a_g \cdot S \leq 0.1 \text{ g}$	C1	C1 ^{d)} or C2 ^{e)}		C2
> low	$a_g \cdot S > 0.1 \text{ g}$	C1	C2		

a) The values defining the seismicity level may be found in the National Annex of EN 1998-1.

b) Definition according to EN 1998-1:2004, 3.2.1

c) $a_g = \gamma_1 \cdot a_{gR}$ Design ground acceleration on type A ground (Ground types as defined in EN 1998-1:2004, Table 3.1);

$\gamma_1 =$ importance factor (see EN 1998-1:2004, 4.2.5);

$a_{gR} =$ reference peak ground acceleration on type A ground (see EN 1998-1:2004, 3.2.1);

S = Soil factor (see e.g. EN 1998-1:2004, 3.2.2).

d) C1 for fixing non-structural elements to structures

e) C2 for fixing structural elements to structures

Table 30: Reduction factor α_{seis}

Loading	Failure mode	Single fastener	Fastener group
Tension	Steel failure	1.0	1.0
	Pull-out failure	1.0	0.85
	Concrete cone failure	0.85	0.75
	Splitting failure	1.0	0.85
Shear	Steel failure	1.0	0.85
	Concrete edge failure	1.0	0.85
	Concrete pry-out failure	0.85	0.75

Würth Injection System W-VIZ/S, W-VIZ/F, W-VIZ/A4, W-VIZ/HCR

**Recommended seismic performance categories for anchors,
Reduction factor α_{eq}**

Annex 23

English translation prepared by DIBt

Marking: e.g. \diamond 80 VMZ M10

- \diamond Identifying mark of manufacturing plant
- 80 Anchorage depth
- VMZ Trade name
- M10 Size of internal thread

A4 additional marking of stainless steel A4

HCR addition marking of high corrosion resistant steel HCR

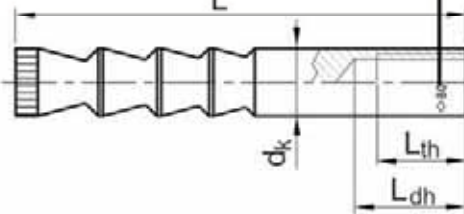

Table 31: Dimensions on anchor rod W-VIZ-IG

Anchor size W-VIZ-IG		40 M6	50 M6	60 M8	75 M8	70 M10	80 M10	90 M12	105 M12	125 M12	115 M16	170 M16	170 M20
Internal thread	-	M6	M6	M8	M8	M10	M10	M12	M12	M12	M16	M16	M20
Number of cones	-	2	3	3	3	3	4	3	4	6	3	6	6
Outer diameter	d_k [mm]	8.0	8.0	9.7	10.7	12.5	12.5	16.5	16.5	16.5	19.7	22.0	24.0
Thread length	L_{th} [mm]	12	15	16	19	20	23	24	27	30	32	32	40
Total length	L [mm]	41	52	63	78	74	84	94	109	130	120	180	182
Length identifier	[mm]	L_{dh} < 18	L_{dh} > 19	L_{dh} < 22.5	L_{dh} > 23.5	L_{dh} < 27	L_{dh} > 28	L_{dh} < 31.5	32.5 < L_{dh} < 34.5	L_{dh} > 35.5	d_k < 21	d_k > 21	-

Table 32: Materials W-VIZ-IG

Part	Designation	Steel, zinc plated	Stainless steel A4	High corrosion resistant steel (HCR)
1	Anchor rod	Steel acc. to EN 10087, galvanised and coated	Stainless steel, 1.4401, 1.4404, 1.4571, 1.4362, EN 10088, coated	High corrosion resistant steel 1.4529, 1.4565 acc. to EN 10088, coated
4	Mortar cartridge	Vinylester resin, styrene free, mineral aggregate 1:10		

Requirements of the fastening screw or the threaded rod and nut

- Minimum screw-in depth L_{sdmin} see Table 34
- The length of screw or the threaded rod must depending on the thickness of fixture t_{fix} , available thread length L_{th} (= maximum available thread length, see Table 34) and the minimum screw-in depth L_{sdmin} be established.
- $A_5 > 8\%$ Ductility

Steel, zinc plated

- Minimum property class 8.8 according to EN ISO 898-1 or EN ISO 898-2

Stainless steel A4

- Material 1.4401; 1.4404; 1.4578; 1.4571; 1.4439; 1.4362 EN 10088
- Minimum property class 70 according to EN ISO 3506

High corrosion resistant steel (HCR)

- Material 1.4529; 1.4565 acc. to EN 10088
- Minimum property class 70 according to EN ISO 3506

Würth Injection System W-VIZ/S, W-VIZ/F, W-VIZ/A4, W-VIZ/HCR

**Dimensions,
Materials
Anchor rod W-VIZ-IG**

Annex 24

Table 33: Installation conditions W-VIZ-IG

Anchor size W-VIZ-IG			M6 – M8	M10 – M20
Nominal diameter of drill hole	d_0	[mm]	< 14	≥ 14
Installation allowable in	dry concrete	-	yes	yes
	wet concrete	-	yes	yes
	water-filled hole ¹⁾	-	no	yes

¹⁾ Special requirements see Section 4.3.

Table 34: Installation parameters W-VIZ-IG

Anchor size W-VIZ-IG		40 M6	50 M6	60 M8	75 M8	70 M10	80 M10	90 M12	105 M12	125 M12	115 M16	170 M16	170 M20
Effective anchorage depth	$h_{ef} =$	[mm]	40	50	60	75	70	80	90	105	125	170	170
Nominal diameter of drill hole	$d_0 =$	[mm]	10	10	12	12	14	14	18	18	22	24	26
Depth of drill hole	$h_0 \geq$	[mm]	42	55	65	80	80	85	98	113	133	180	185
Diameter of cleaning brush	$D \geq$	[mm]	10.8	10.8	13.0	13.0	15.0	15.0	19.0	19.0	23.0	25.0	27.0
Installation torque	$T_{inst} \leq$	[Nm]	8	8	10	10	15	15	25	25	50	50	80
Diameter of clearance hole in the fixture	$d_f \leq$	[mm]	7	7	9	9	12	12	14	14	18	18	22
Available thread length	L_{th}	[mm]	12	15	16	19	20	23	24	27	30	32	40
Minimum screw-in depth	L_{sdmin}	[mm]	7	7	9	9	12	12	14	14	18	18	22

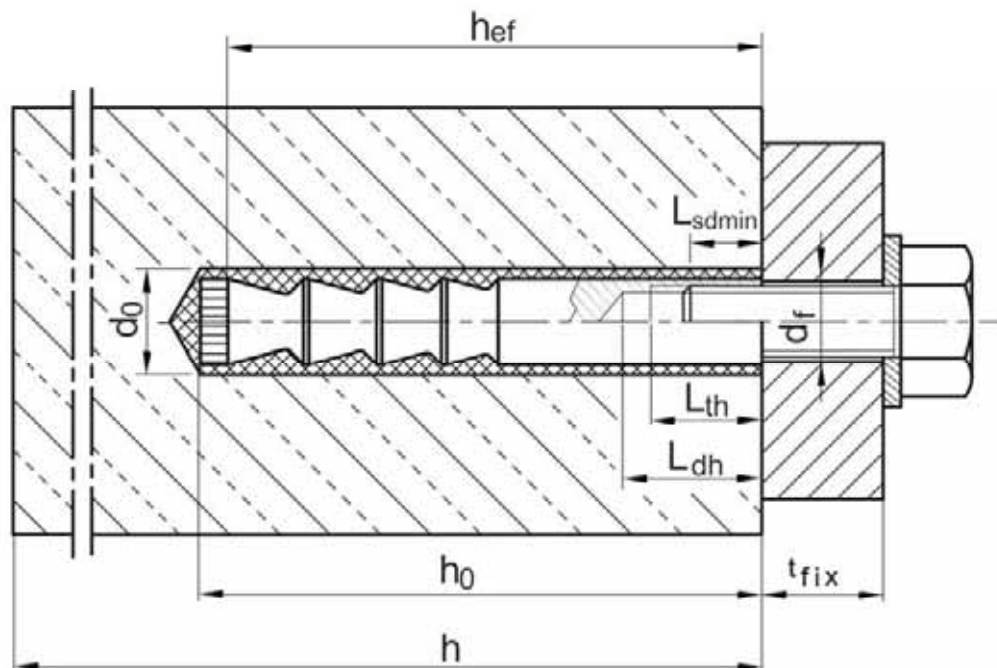

Würth Injection System W-VIZ/S, W-VIZ/F, W-VIZ/A4, W-VIZ/HCR

**Installation conditions,
Installation parameters
Anchor rod W-VIZ-IG**

Annex 25

Installation instructions W-VIZ-IG

Making and cleaning of hammer drilled holes

1		Use Hammer drill or air drill with drill bit and depth gauge. Drill perpendicular to concrete surface.
		Drill hole must be cleaned directly prior to installation of the anchor.
2		W-VIZ-IG M6 - M12: Blow out drill hole from the bottom with Würth Blow-out pump at least two times. The Extension Tube with reduced diameter must be added to the Blow-out pump for the diameter M8.
		W-VIZ-IG M16 - M20: Connect Würth Air Blower to compressed air (min. 6 bar, oil-free). Open air valve and blow out drill hole along the entire depth with back and forth motion at least two times.
3		Check diameter of Würth Cleaning Brush. If Brush can be pushed into the drill hole without any resistance, it must be replaced. Chuck Brush into drill machine. Turn on drill machine. Brush drill hole back and forth along the entire drill hole depth at least two times while rotated by drill machine.
4		W-VIZ-IG M6 - M12: Blow out drill hole from the bottom with Würth Blow-out pump at least two times. The Extension Tube with reduced diameter must be added to the Blow-out pump for the diameter M8.
		W-VIZ-IG M16 - M20: Connect Würth Air Blower to compressed air (min. 6 bar, oil-free). Open air valve and blow out drill hole along the entire depth with back and forth motion at least two times.

Making and cleaning of diamond drilled holes

1		Use diamond drill with diamond drill bit and depth gauge. Drill perpendicular to concrete surface.
		Drill hole must be cleaned directly prior to installation of the anchor.
2		Remove drill core at least up to the nominal hole depth and check drill hole depth.
3		Flushing of drill hole: Flush drill hole with water, starting from the bottom, until clear water gets out of the drill hole.
4		Connect Würth Air Blower to compressed air (min. 6 bar, oil-free). Open air valve and blow out drill hole along the entire depth with back and forth motion at least two times.

Würth Injection System W-VIZ/S, W-VIZ/F, W-VIZ/A4, W-VIZ/HCR



Installation instructions
- Drilling and cleaning -
Anchor rod W-VIZ-IG

Annex 26

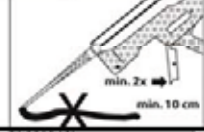
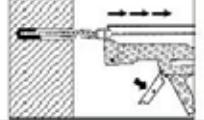
Injection

5		<p>Check expiration date on WIT-VM 100 or WIT-Express cartridge. Never use when expired. Remove cap from cartridge. Screw Mixer Nozzle on cartridge. When using a new cartridge always use a new Mixer Nozzle. Never use cartridge without Mixer Nozzle and never use Mixer Nozzle without helix inside.</p>
6		<p>Insert cartridge in Dispenser. Before injecting discard mortar (at least 2 full strokes or a line of 10 cm) until it shows a consistent grey colour. Never use this mortar.</p>
7		<p>Prior to injection check if Mixer Nozzle reaches the bottom of the drill hole. If it does not reach the bottom, plug Mixer Extension onto Mixer Nozzle in order to properly fill the drill hole. Fill cleaned drill hole with a sufficient quantity of injection mortar. Start from the bottom of the drill hole and work out to avoid trapping air pockets.</p>

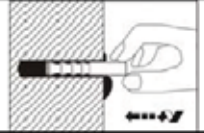
Setting of anchor

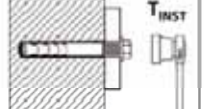
8		<p>Insert the anchor W-VIZ-IG rod by hand, rotating slightly up to about 1mm below the concrete surface in the drill hole. The anchor rod is properly set when excess mortar seeps from the hole. If the hole is not completely filled, up out anchor rod, let mortar cure, drill out hole and start again from No. 2.</p>
9		<p>Follow minimum curing time shown in Table 35: and Table 36:.. During curing time anchor rod must not be moved or loaded.</p>
10		<p>Remove excess mortar.</p>
11		<p>The fixture can be mounted after curing time. Apply installation torque T_{inst} according to Table 34: by using torque wrench</p>

Würth Injection System W-VIZ/S, W-VIZ/F, W-VIZ/A4, W-VIZ/HCR

Installation instructions
- Anchor installation -
Anchor rod W-VIZ-IG

Annex 27

Table 35: Maximum processing time and minimum curing time WIT-VM 100

Temperature [°C] in the drill hole	Maximum processing time	Minimum curing time	
		dry concrete	wet concrete
+ 40 °C	1.4 min	15 min	30 min
+ 35 °C to +39 °C	1.4 min	20 min	40 min
+ 30 °C to +34 °C	2 min	25 min	50 min
+ 20 °C to +29 °C	4 min	45 min	1:30 h
+ 10 °C to + 19 °C	6 min	1:20 h	2:40 h
+ 5 °C to + 9°C	12 min	2:00 h	4:00 h
0 °C to + 4°C	20 min	3:00 h	6:00 h
- 4 °C to -1 °C	45 min	6:00 h	12:00 h ¹⁾
- 5 °C	1:30 h	6:00 h	12:00 h ¹⁾

Table 36: Maximum processing time and minimum curing time WIT-Express

Temperature [°C] in the drill hole	Maximum processing time	Minimum curing time	
		dry concrete	wet concrete
+ 30 °C	1 min	10 min	20 min
+ 20 °C to + 29 °C	1 min	20 min	40 min
+ 10 °C to + 19 °C	3 min	40 min	80 min
+ 5 °C to + 9 °C	6 min	1:00 h	2:00 h
0 °C to + 4 °C	10 min	2:00 h	4:00 h
- 4 °C to -1 °C	20 min	4:00 h	8:00 h ¹⁾
-5 °C	40 min	4:00 h	8:00 h ¹⁾

¹⁾ It must be ensured that icing does not occur in the drill hole. The hole must be drilled and cleaned directly prior to the installation of the anchor.

Table 37: Minimum thickness of concrete, minimum spacing and edge distance, W-VIZ-IG

Anchor size W-VIZ-IG			40 M6	50 M6	60 M8	75 M8	70 M10	80 M10	90 M12	105 M12	125 M12	115 M16	170 M16	170 M20
Minimum thickness of concrete	h_{min}	[mm]	80	80	100	110	110	110	130	150	170 160 ²⁾	160	230 220 ²⁾	230 220 ²⁾
Cracked concrete														
Minimum spacing	s_{min}	[mm]	40	40	40	40	55	40	50	50	60	80	80	80
Minimum edge distance	c_{min}	[mm]	40	40	40	40	55	50	50	50	60	80	80	80
Non-cracked concrete														
Minimum spacing	s_{min}	[mm]	40	40	50	50	55	55	50	60	60	80	80	80
Minimum edge distance	c_{min}	[mm]	40	40	50	50	55	55	50	60	60	80	80	80

²⁾ The remote face of the concrete member shall be inspected to ensure there has been no break-through by drilling. In case of break-through the ground of the drill hole shall be closed with high strength mortar. The full bonded length h_{ef} shall be achieved and any potential loss of injection mortar shall be compensated.

Würth Injection System W-VIZ/S, W-VIZ/F, W-VIZ/A4, W-VIZ/HCR

**Processing time, curing time,
Minimum thickness of concrete, Minimum spacing and edge distance,
Anchor rod W-VIZ-IG**

Annex 28

Table 38: Characteristic values for tension load under static or quasi-static action, ETAG 001, Annex C, design method A, W-VIZ-IG

Anchor size W-VIZ-IG		40 M6	50 M6	60 M8	75 M8	70 M10	80 M10	90 M12	105 M12	125 M12	115 M16	170 M16	170 M20	
Steel failure														
Characteristic tension resistance $N_{Rk,s}$	Steel, zinc plated	[kN]	15	16	19	29	35	35	67	67	67	52	125	108
	Stainless steel A4, HCR	[kN]	11	11	19	21	33	33	47	47	47	65	88	94
Partial safety factor	γ_{Ms}	[-]	1.5											
Pullout														
Characteristic resistance $N_{Rk,p}$ in cracked concrete C20/25	$50^{\circ}\text{C}^2)/80^{\circ}\text{C}^3)$	[kN]	1)											
	$72^{\circ}\text{C}^2)/120^{\circ}\text{C}^3)$	[kN]	5	7.5	12	12	16	20	20	30	50	30	60	75
Characteristic resistance $N_{Rk,p}$ in cracked concrete C20/25	$50^{\circ}\text{C}^2)/80^{\circ}\text{C}^3)$	[kN]	9	1)										
	$72^{\circ}\text{C}^2)/120^{\circ}\text{C}^3)$	[kN]	6	9	16	16	16	25	25	35	50	40	75	95
Splitting for standard thickness of concrete (The higher resistance of Case 1 and Case 2 may be applied.)														
Standard thickness of concrete	$h_{std} \geq 2h_{ef}$	[mm]	100	100	120	150	140	160	180	200	250	230	340	340
Case 1														
Characteristic resistance in concrete C20/25	$N^0_{Rk,sp}$ 4)	[kN]	7.5	9	16	20	20	1)	40	50	50	1)		
Respective spacing	$S_{cr,sp}$	[mm]	3 h_{ef}											
Respective edge distance	$C_{cr,sp}$	[mm]	1.5 h_{ef}											
Case 2														
Spacing	$S_{cr,sp}$	[mm]	6 h_{ef}	6 h_{ef}	5 h_{ef}	7 h_{ef}	5 h_{ef}	3 h_{ef}	4 h_{ef}	4 h_{ef}	4 h_{ef}	3 h_{ef}	3 h_{ef}	3 h_{ef}
Edge distance	$C_{cr,sp}$	[mm]	3 h_{ef}	3 h_{ef}	2.5 h_{ef}	3.5 h_{ef}	2.5 h_{ef}	1.5 h_{ef}	2 h_{ef}	2 h_{ef}	2 h_{ef}	1.5 h_{ef}	1.5 h_{ef}	1.5 h_{ef}
Splitting for minimum thickness of concrete (The higher resistance of Case 1 and Case 2 may be applied.)														
Minimum thickness of concrete	$h_{min} \geq$	[mm]	80	80	100	110	110	110	130	150	160	160	220	220
Case 1														
Characteristic resistance in concrete C20/25	$N^0_{Rk,sp}$ 4)	[kN]	7.5	-	16	16	20	25	35	50	40	-	75	1)
Respective spacing	$S_{cr,sp}$	[mm]	3 h_{ef}											
Respective edge distance	$C_{cr,sp}$	[mm]	1.5 h_{ef}											
Case 2														
Spacing	$S_{cr,sp}$	[mm]	6 h_{ef}	7 h_{ef}	6 h_{ef}	7 h_{ef}	7 h_{ef}	6 h_{ef}	5 h_{ef}	5 h_{ef}	6 h_{ef}	5 h_{ef}	5.2 h_{ef}	5.2 h_{ef}
Edge distance	$C_{cr,sp}$	[mm]	3 h_{ef}	3.5 h_{ef}	3 h_{ef}	3.5 h_{ef}	3.5 h_{ef}	3 h_{ef}	2.5 h_{ef}	2.5 h_{ef}	3 h_{ef}	2.5 h_{ef}	2.6 h_{ef}	2.6 h_{ef}
Increasing factors for $N_{Rk,p}$ and $N^0_{Rk,sp}$	ψ_c	C25/30	[-]	1.10										
		C30/37	[-]	1.22										
		C40/50	[-]	1.41										
		C45/55	[-]	1.48										
		C50/60	[-]	1.55										
Concrete cone failure														
Effective anchorage depth	h_{ef}	[mm]	40	50	60	75	70	80	90	105	125	115	170	170
Spacing	$S_{cr,N}$	[mm]	3 h_{ef}											
Edge distance	$C_{cr,N}$	[mm]	1.5 h_{ef}											
Partial safety factor	$\gamma_{Mp} = \gamma_{Msp} = \gamma_{Mc}$	[-]	1.5											

1) Pullout failure is not decisive
 2) Maximum long term temperature
 3) Maximum short term temperature
 4) For the proof against splitting failure according to ETAG 001 Annex C, $N^0_{Rk,c}$ in equation (5.3) has to be replaced by $N^0_{Rk,sp}$ with consideration of the member thickness ($\psi_{ucr,sp} = 1.0$).

Würth Injection System W-VIZ/S, W-VIZ/F, W-VIZ/A4, W-VIZ/HCR

Characteristic values for tension loads under static or quasi-static action, ETAG 001, Annex C, design method A, Anchor rod W-VIZ-IG

Annex 29

Table 39: Displacements under tension loads, W-VIZ-IG

Anchor size W-VIZ-IG			40 M6	50 M6	60 M8	75 M8	70 M10	80 M10	90 M12	105 M12	125 M12	115 M16	170 M16	170 M20
Tension load in cracked concrete	N	[kN]	4.3	6.1	8.0	11.1	10.0	12.3	14.6	18.4	24.0	21.1	38.0	38.0
Displacement	δ_{N0}	[mm]	0.5	0.5	0.5	0.6	0.6	0.6	0.7	0.7	0.7	0.7	0.8	0.8
	$\delta_{N\infty}$	[mm]	1.3									1.1	1.3	
Tension load in non-cracked concrete	N	[kN]	4.3	8.5	11.1	15.6	14.1	17.2	20.5	25.9	33.0	29.6	53.3	53.3
Displacement	δ_{N0}	[mm]	0.2	0.4	0.4	0.4	0.4	0.4	0.6	0.6	0.6	0.5	0.6	0.6
	$\delta_{N\infty}$	[mm]	1.3									1.1	1.3	

Table 40: Characteristic values for shear load under static or quasi-static action, ETAG 001, Annex C, design method A, W-VIZ-IG

Anchor size W-VIZ-IG			40 M6	50 M6	60 M8	75 M8	70 M10	80 M10	90 M12	105 M12	125 M12	115 M16	170 M16	170 M20
Steel failure without lever arm														
Characteristic shear resistance $V_{Rk,s}$	Steel, zinc plated	[kN]	8	8	9,5	15	18	18	34	34	34	26	63	54
	Stainless steel A4, HCR	[kN]	5.5	5.5	9.5	10	16	16	24	24	24	32	44	47
Partial safety factor	γ_{Ms}	[-]	1.25											
Steel failure with lever arm														
Characteristic bending moments $M^0_{Rk,s}$	Steel, zinc plated	[kN]	12	12	30	30	60	60	105	105	105	212	266	519
	Stainless steel A4, HCR	[kN]	8.5	8.5	21	21	42	42	74	74	74	187	187	365
Partial safety factor	γ_{Ms}	[-]	1.25											
Concrete pryout failure														
Factor in equation (5.6) ETAG Annex C, 5.2.3.3	k	[-]	2											
Partial safety factor	γ_{Mcp}	[-]	1.5											
Concrete edge failure														
Effective length of anchor in shear load	l_f	[mm]	40	50	60	75	70	80	90	105	125	115	170	170
Diameter of anchor	d_{nom}	[mm]	10	10	12	12	14	14	18	18	18	22	24	26
Partial safety factor	γ_{Mc}	[-]	1.5											

Table 41: Displacements under shear loads, W-VIZ-IG

Anchor size W-VIZ-IG			40 M6	50 M6	60 M8	75 M8	70 M10	80 M10	90 M12	105 M12	125 M12	115 M16	170 M16	170 M20
Shear load	V	[kN]	4.6	4.6	5.4	8.4	10.1	10.1	19.3	19.3	19.3	14.8	35.8	30.7
Displacements	δ_{V0}	[mm]	0.4	0.4	0.5	0.4	0.5	0.5	1.2	1.2	1.2	0.8	1.9	1.2
	$\delta_{V\infty}$	[mm]	0.7	0.7	0.8	0.7	0.8	0.8	1.9	1.9	1.9	1.2	2.8	1.9
Shear load	V	[kN]	3.2	3.2	5.4	5.9	9.3	9.3	13.5	13.5	13.5	18.5	25.2	26.9
Displacements	δ_{V0}	[mm]	0.3	0.3	0.5	0.3	0.5	0.5	0.9	0.9	0.9	1.0	1.4	1.1
	$\delta_{V\infty}$	[mm]	0.4	0.4	0.7	0.5	0.7	0.7	1.4	1.4	1.4	1.5	2.1	1.6

Würth Injection System W-VIZ/S, W-VIZ/F, W-VIZ/A4, W-VIZ/HCR

Characteristic values for shear loads under static or quasi-static action, ETAG 001, Annex C, design method A, displacements, Anchor rod W-VIZ-IG

Annex 30

Table 42: Characteristic values for tension loads under static or quasi-static action, CEN/TS 1992-4, design method A, W-VIZ-IG

Anchor size W-VIZ-IG		40	50	60	75	70	80	90	105	125	115	170	170	
		M6	M6	M8	M8	M10	M10	M12	M12	M12	M16	M16	M20	
Steel failure														
Characteristic tension resistance $N_{Rk,s}$	Steel, zinc plated	[kN]	15	16	19	29	35	35	67	67	67	52	125	108
	Stainless steel A4, HCR	[kN]	11	11	19	21	33	33	47	47	47	65	88	94
Partial safety factor	γ_{Ms}	[-]	1.5											
Pullout														
Characteristic resistance $N_{Rk,p}$ in cracked concrete C20/25	$50^{\circ}C^{2)/80^{\circ}C^{3)}$	[kN]	1)											
	$72^{\circ}C^{2)/120^{\circ}C^{3)}$	[kN]	5	7,5	12	12	16	20	20	30	50	30	60	75
Characteristic resistance $N_{Rk,p}$ in non-cracked concrete C20/25	k_s	[-]	7.2											
	$50^{\circ}C^{2)/80^{\circ}C^{3)}$	[kN]	9	1)										
	$72^{\circ}C^{2)/120^{\circ}C^{3)}$	[kN]	6	9	16	16	16	25	25	35	50	40	75	95
	k_s	[-]	10.1											
Splitting for standard thickness of concrete (The higher resistance of Case 1 and Case 2 may be applied.)														
Standard thickness of concrete	$h_{std} \geq 2h_{ef}$	[mm]	100	100	120	150	140	160	180	200	250	230	340	340
Case 1														
Characteristic resistance in concrete C20/25	$N^0_{Rk,sp}$ 4)	[kN]	7.5	9	16	20	20	1)	40	50	50	1)		
Respective spacing	$s_{cr,sp}$	[mm]	3 h_{ef}											
Respective edge distance	$c_{cr,sp}$	[mm]	1.5 h_{ef}											
Case 2														
Spacing	$s_{cr,sp}$	[mm]	6 h_{ef}	6 h_{ef}	5 h_{ef}	7 h_{ef}	5 h_{ef}	3 h_{ef}	4 h_{ef}	4 h_{ef}	4 h_{ef}	3 h_{ef}	3 h_{ef}	3 h_{ef}
Edge distance	$c_{cr,sp}$	[mm]	3 h_{ef}	3 h_{ef}	2.5 h_{ef}	3.5 h_{ef}	2.5 h_{ef}	1.5 h_{ef}	2 h_{ef}	2 h_{ef}	2 h_{ef}	1.5 h_{ef}	1.5 h_{ef}	1.5 h_{ef}
Splitting for minimum thickness of concrete (The higher resistance of Case 1 and Case 2 may be applied.)														
Minimum thickness of concrete	$h_{min} \geq$	[mm]	80	80	100	110	110	110	130	150	160	160	220	220
Case 1														
Characteristic resistance in concrete C20/25	$N^0_{Rk,sp}$ 4)	[kN]	7.5	-	16	16	20	25	35	50	40	-	75	1)
Respective spacing	$s_{cr,sp}$	[mm]	3 h_{ef}											
Respective edge distance	$c_{cr,sp}$	[mm]	1.5 h_{ef}											
Case 2														
Spacing	$s_{cr,sp}$	[mm]	6 h_{ef}	7 h_{ef}	6 h_{ef}	7 h_{ef}	7 h_{ef}	6 h_{ef}	5 h_{ef}	5 h_{ef}	6 h_{ef}	5 h_{ef}	5.2 h_{ef}	5.2 h_{ef}
Edge distance	$c_{cr,sp}$	[mm]	3 h_{ef}	3.5 h_{ef}	3 h_{ef}	3.5 h_{ef}	3.5 h_{ef}	3 h_{ef}	2.5 h_{ef}	2.5 h_{ef}	3 h_{ef}	2.5 h_{ef}	2.6 h_{ef}	2.6 h_{ef}
Increasing factors for $N_{Rk,p}$ and $N^0_{Rk,sp}$	ψ_c	[-]	1.10											
		[-]	1.22											
		[-]	1.41											
		[-]	1.48											
		[-]	1.55											
Concrete cone failure														
Effective anchorage depth	h_{ef}	[mm]	40	50	60	75	70	80	90	105	125	115	170	170
Factor for cracked concrete	k_{cr}	[-]	7.2											
Factor for non-cracked concrete	k_{ucr}	[-]	10,1											
Spacing	$s_{cr,N}$	[mm]	3 h_{ef}											
Edge distance	$c_{cr,N}$	[mm]	1.5 h_{ef}											
Partial safety factor	$\gamma_{Mp} = \gamma_{Msp} = \gamma_{Mc}$	[-]	1.5											

1) Pullout failure is not decisive
 2) Maximum long term temperature
 3) Maximum short term temperature
 4) For the proof against splitting failure according to CEN/TS 1992-4-5, $N^0_{Rk,c}$ in equation (23) has to be replaced by $N^0_{Rk,sp}$ with consideration of the member thickness ($\psi_{ucr,N} = 1.0$).

Würth Injection System W-VIZ/S, W-VIZ/F, W-VIZ/A4, W-VIZ/HCR

Characteristic values for tension loads under static or quasi-static action, CEN/TS 1992-4, design method A, Anchor rod W-VIZ-IG

Annex 31

Table 43: Displacements under tension loads, W-VIZ-IG

Anchor size W-VIZ-IG			40 M6	50 M6	60 M8	75 M8	70 M10	80 M10	90 M12	105 M12	125 M12	115 M16	170 M16	170 M20
Tension load in cracked concrete	N	[kN]	4.3	6.1	8.0	11.1	10.0	12.3	14.6	18.4	24.0	21.1	38.0	38.0
Displacement	δ_{N0}	[mm]	0.5	0.5	0.5	0.6	0.6	0.6	0.7	0.7	0.7	0.7	0.8	0.8
	$\delta_{N\infty}$	[mm]	1.3									1.1	1.3	
Tension load in non-cracked concrete	N	[kN]	4.3	8.5	11.1	15.6	14.1	17.2	20.5	25.9	33.0	29.6	53.3	53.3
Displacement	δ_{N0}	[mm]	0.2	0.4	0.4	0.4	0.4	0.4	0.6	0.6	0.6	0.5	0.6	0.6
	$\delta_{N\infty}$	[mm]	1.3									1.1	1.3	

Table 44: Characteristic values for shear load under static or quasi-static action, CEN/TS 1992-4, design method A, W-VIZ-IG

Anchor size W-VIZ-IG			40 M6	50 M6	60 M8	75 M8	70 M10	80 M10	90 M12	105 M12	125 M12	115 M16	170 M16	170 M20
Steel failure without lever arm														
Characteristic shear resistance $V_{Rk,s}$	Steel, zinc plated	[kN]	8	8	9,5	15	18	18	34	34	34	26	63	54
	Stainless steel A4, HCR	[kN]	5.5	5.5	9.5	10	16	16	24	24	24	32	44	47
Ductility factor	k_2	[-]	1,0											
Partial safety factor	γ_{Ms}	[-]	1.25											
Steel failure with lever arm														
Characteristic bending moments $M^0_{Rk,s}$	Steel, zinc plated	[kN]	12	12	30	30	60	60	105	105	105	212	266	519
	Stainless steel A4, HCR	[kN]	8.5	8.5	21	21	42	42	74	74	74	187	187	365
Partial safety factor	γ_{Ms}	[-]	1.25											
Concrete pryout failure														
Factor in equation (27) CEN/TS 1992-4-5, 6.3.3	k_3	[-]	2											
Partial safety factor	γ_{Mcp}	[-]	1.5 ²⁾											
Concrete edge failure														
Effective length of anchor in shear load	l_f	[mm]	40	50	60	75	70	80	90	105	125	115	170	170
Diameter of anchor	d_{nom}	[mm]	10	10	12	12	14	14	18	18	18	22	24	26
Partial safety factor	γ_{Mc}	[-]	1.5 ²⁾											

Table 45: Displacements under shear loads W-VIZ-IG

Anchor size W-VIZ-IG			40 M6	50 M6	60 M8	75 M8	70 M10	80 M10	90 M12	105 M12	125 M12	115 M16	170 M16	170 M20
Shear load	V	[kN]	4.6	4.6	5.4	8.4	10.1	10.1	19.3	19.3	19.3	14.8	35.8	30.7
Displacements	δ_{V0}	[mm]	0.4	0.4	0.5	0.4	0.5	0.5	1.2	1.2	1.2	0.8	1.9	1.2
	$\delta_{V\infty}$	[mm]	0.7	0.7	0.8	0.7	0.8	0.8	1.9	1.9	1.9	1.2	2.8	1.9
Shear load	V	[kN]	3.2	3.2	5.4	5.9	9.3	9.3	13.5	13.5	13.5	18.5	25.2	26.9
Displacements	δ_{V0}	[mm]	0.3	0.3	0.5	0.3	0.5	0.5	0.9	0.9	0.9	1.0	1.4	1.1
	$\delta_{V\infty}$	[mm]	0.4	0.4	0.7	0.5	0.7	0.7	1.4	1.4	1.4	1.5	2.1	1.6

Würth Injection System W-VIZ/S, W-VIZ/F, W-VIZ/A4, W-VIZ/HCR

Characteristic values for shear loads under static or quasi-static action, CEN/TS 1992-4, design method A, displacements, Anchor rod W-VIZ-IG

Annex 32